

WIN  CARE

MANGAR

EAGLE LIFTING CUSHION

USER INSTRUCTIONS



Exclusively distributed by

 **aidacare**
HEALTHCARE EQUIPMENT

Table of Contents

Warnings	3
Intended Use	3
Standard Product Contents	4
Connecting the Hand Control and Airflo 24	4
Switching the Airflo 24 'On' & 'Off'	5
Positioning the patient on the Eagle	5
Operating	5
After Use	7
Routine Cleaning	7
Disinfecting	7
Maintenance	7
Transportation/Storage	8
Disposal/Recycling	8
Troubleshooting	8
Specifications	9
Warranty	9
Declaration of Conformity	10



Ensure that you read and understand this instruction manual before using this product. Failure to follow the instructions and safety precautions in this manual can result in damage and/or serious injury.



Please keep these instructions in a safe location for future reference

WARNINGS

- This equipment **MUST** only be used by persons familiar in its use.
- The medical state of a person needing to be raised **MUST** be assessed before commencing a lift.
- Ensure that the surface on which the Eagle is to be placed is free from sharp objects. **NOTE:** Place a blanket, groundsheet, towel or similar under the Eagle if using it on a rough surface.
- If a slide sheet has been used to transfer the patient onto the Eagle it must be removed from under the patient before commencing a lift.
- Sections 2, 3 and 4 **MUST** always be fully inflated in sequence from the bottom up, in order to maintain stability. **NOTE:** The backrest may be partially inflated before any other section is raised. Once the lowest section is fully inflated, the backrest can be raised further as required.
- Do not operate the Airflo 24 compressor in the presence of flammable anaesthetic mixtures with air, oxygen or nitrous oxide, as these mixtures can create a combustible environment leading to the potential for fire or even an explosion in the presence of a spark.

Intended Use

The Mangar Eagle is an inflatable lifting device which is designed to sit up and lift a fallen person from the floor. When inflated, the Eagle lifts the patient into a raised seated position ready to stand with or without assistance.

The Eagle is powered by a Mangar Airflo 24 Compressor and controlled using a 4-Way Hand Control. This equipment may be used with or without a helper as required.

Patented



PLEASE REFER TO THE SEPARATE AIRFLO 24 COMPRESSOR INSTRUCTIONS BEFORE OPERATING.

Standard Product Contents - fig. ①

- 1 x Eagle (A) (including carrying bag).
- 1 x 4-Way Hand Control (B).
- 1 x Airflo 24 Compressor (C) with user instructions.

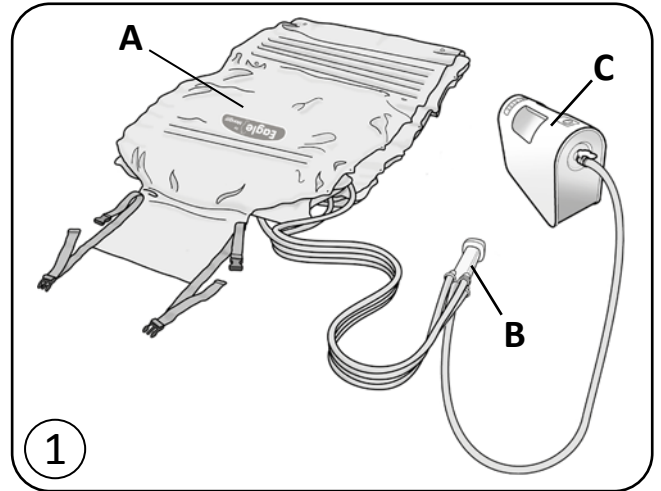

Connecting the Hand Control and Airflo 24 - fig. ② & fig. ③

- Remove the Eagle from the carrying bag, unfasten the straps and unroll.
- Ensure the tab (A fig.2) on the backrest strut has been pulled out and is not hidden under the backrest before operating the Eagle.
- Connect the four hoses from the hand control to the corresponding numbered and coloured connectors on the Eagle (A fig.3).
- Connect the hose (B fig.3) from the hand control to the Airflo 24 compressor.
- Position the Airflo 24 compressor so that it will not be in the way while positioning the patient. Ensure that the hoses are not kinked.

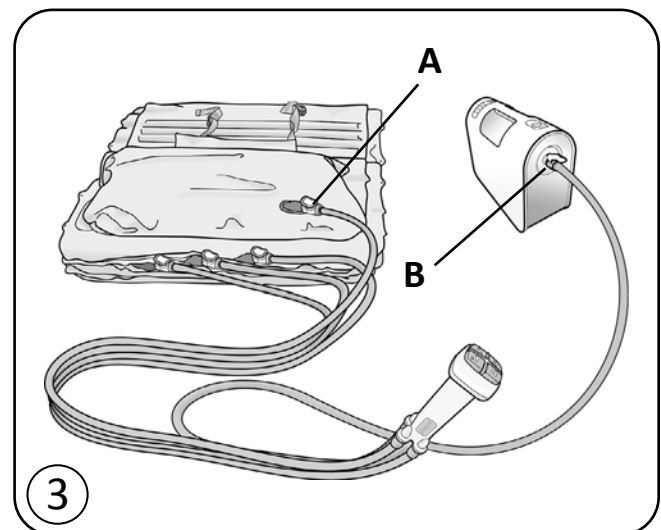
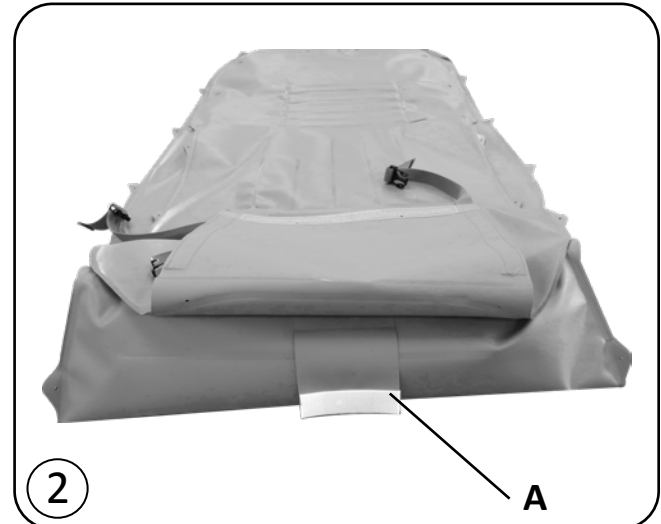



Switching the Airflo 24 'On' & 'Off' - fig. ④

- To switch on, momentarily press the 'Power' button (**A** fig.4). The bottom battery status indicator light (**B**) will come on.
- To switch off, momentarily press the 'Power' button. The bottom battery status indicator light will go out.

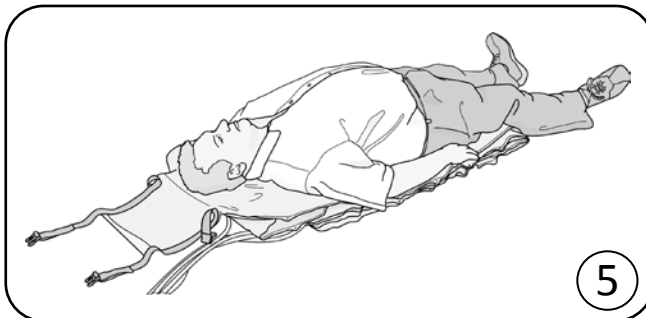

Positioning the patient on the Eagle - fig. ⑤

- Position the Eagle at the side of the patient so that the patient's shoulders are level with the Eagle badge. **NOTE:** Place a blanket, groundsheet, towel or similar under the Eagle if using it on a rough surface.
- Transfer the patient onto the Eagle. The shoulders should lie on the Eagle badge and the body should lie centrally.

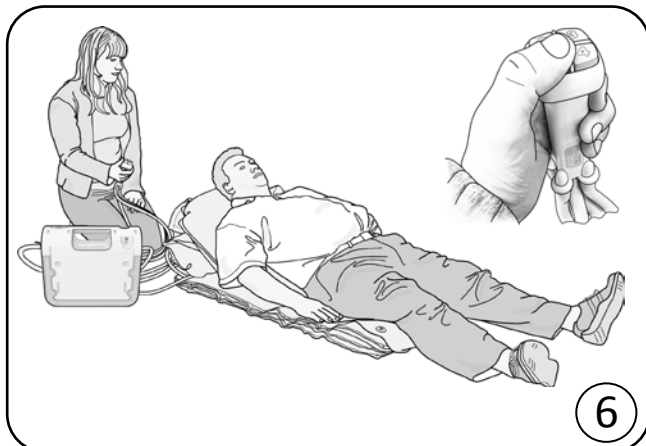

Operating

The following instructions apply equally when the Eagle is being operated by a person raising themselves without assistance, or by an assistant raising a patient.

WARNING: If a slide sheet has been used to transfer the patient onto the Eagle it must be removed from under the patient before commencing a lift.

- Switch the Airflo 24 to 'On'. Press the number 1 button on the hand control to partially inflate the backrest section until the patient is in a comfortable position - fig. ⑥
- Press the number 2 button to inflate the bottom section until it becomes rigid - fig. ⑦

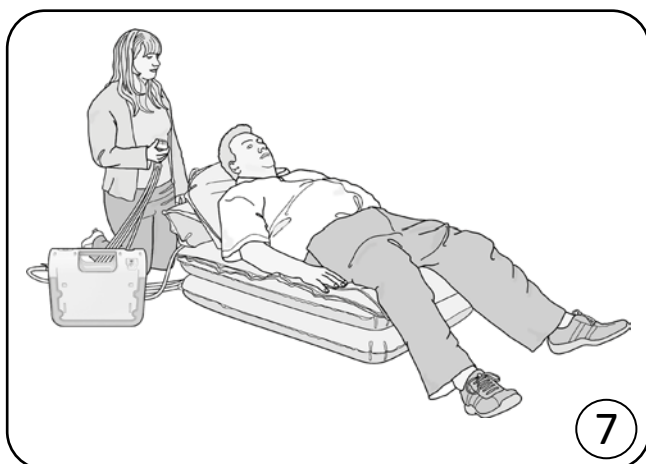

- Continue to press buttons 3 and 4 **in sequence** until the sections become rigid - fig. ⑧



- Press button 1 to fully raise the backrest and arrive at a sitting position - fig. ⑨



- Whether assisted or used alone, the patient should now be in a position to stand or transfer - fig. ⑩

WARNING: In order to maintain stability, sections must always be **fully** inflated from the bottom up, in sequence.

Note: only the backrest (section 1) may be partially inflated before the lower sections.



After Use

- To deflate, disconnect each of the air hoses from the Eagle. **NOTE:** The initial ‘rush’ of air as the hoses are disconnected from the Eagle, can be reduced by first disconnecting the air hose from the Airflo 24 and then pressing each of the buttons on the hand control.
- Roll up the Eagle with the hand control in the hollow (**A**)- fig. ⑪ secure the straps and place in the carrying bag- fig. ⑫

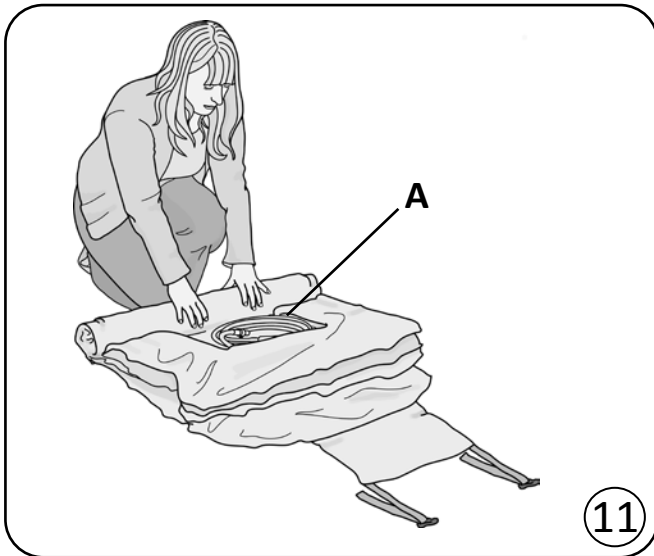

Routine Cleaning

Fully inflate all sections of the Eagle, sponge clean with a non abrasive proprietary liquid cleaner or disinfectant and dry thoroughly. **Do not dry using hot air.**

Disinfecting

The Eagle should be fully inflated and pre-cleaned by washing with detergent and water, thoroughly rinsed and then disinfected using a 1:10 solution of household liquid bleach and water (1 part bleach to 10 parts cold water). Leave the solution on the Eagle for approximately 10 minutes before thoroughly rinsing off with clean cold water. Allow to air dry before storage. **Do not dry using hot air.**

Maintenance

Other than routine cleaning, the Eagle is maintenance free.

WinnCare recommends that your Eagle Lifting Cushion is inspected annually by either your supplier or other suitably qualified person.

For further information contact Aidacare on 1300 133 120 or email sales@aidacare.com.au.



Transportation / Storage

Disconnect the Airflo 24 compressor from the Eagle before transporting so as to avoid accidental inflation of the cushion.

Ensure that the Eagle is clean and thoroughly dry before storing. Failure to thoroughly dry the cushion before storage may result in a build-up of mould on the surface of the product leading to a weakening of the fabric and consequential invalidation of the product warranty. Store in a dry environment.

To maintain the Airflo 24 battery when being stored for long periods, put on charge for 12 hours every 3 months.

Disposal / Recycling

When the Eagle has reached the end of its working life, dispose of it at your local recycling centre (civic amenity site).

When the Airflo 24 has reached the end of its working life, remove the battery for safe disposal in accordance with your local council guidelines, and dispose of the Airflo 24 at your local recycling centre (civic amenity site).

Troubleshooting	
Problem	Remedy
Compressor does not run when one or more of the buttons are pressed on the hand control.	Ensure that all the air hoses from the hand control are connected to the Eagle and Airflo
Compressor keeps stopping when trying to inflate the Eagle.	Check that there are no kinks in the air hoses.
Bottom Battery Status Indicator light flashing 'Red'.	This happens when the compressor's internal temperature cut-out has tripped. Leave the Airflo 24 for 60-90 minutes to cool.
Compressor causes electrical interference with another piece of electrical equipment.	Move either the compressor or other item further away from each other until the interference stops.
For further information contact Aidacare on 1300 133 120 or email sales@aidacare.com.au	

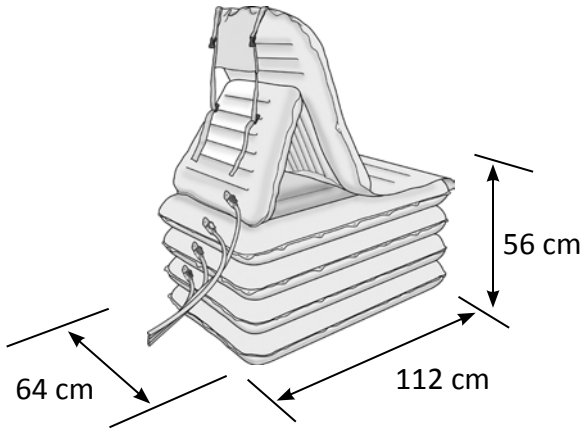

Specifications

Maximum user weight:	220kg (490lbs)
Seat height (approx):	56cm (22")
Overall length (approx):	112cm (44")
Overall width (approx):	64cm (25")
Deflated & rolled (in bag):	
Length :	72cm (28")
Diameter:	26cm (10")
Weight (Inc. Hand Control):	6.3kg (13.9lbs)
Maximum air pressure:	0.35bar (5psi)
Max / Min temperature:	+50°C / -15°C (122°F/5°F)

Warranty

The warranty is given against defects in material and workmanship and comprises piece, parts and labour. The warranty is not valid in the case of fair wear and tear, wilful damage, common neglect, misuse or unauthorised alteration or repair by unqualified persons.

The following statements do not affect the consumer's statutory rights. This product is sold on the understanding that in the event of any defect of manufacture or material appearing within the warranty period, the defect will be rectified free of charge providing that:

- (a) Reasonable evidence is provided (e.g. purchase invoice, delivery note) that the claim is being made within the warranty period.
- (b) The defect is not attributable to accidental damage (either in transit or otherwise), misuse or unauthorised repair.

Eagle serial number:
Airflo 24 serial number:
Date of purchase:
Invoice/Delivery note number:

Mangar International Ltd, trading as WinnCare, reserves the right to alter product specifications and/or any of the information contained within this document without notice.

Declaration of Conformity

Mangar International as manufacturer hereby declares that the following products conform to the:

- Applicable provisions of Regulation (EU) 2017/745 of the European Parliament and of the Council of 5 April 2017
- UK Medical Devices Regulations 2002

and following standards:

BS EN 60601-1-6:2010 and A1:2015.

BS EN 60601-1:2006 and A12:2014.

BS EN 60601-1-11:2015.

BS EN 62366-1:2015.

Trade name: Airflo 24 with Eagle Lifting Cushion

Basic UDI-DI: 5020833MPCA210400NX

Product Classification: ISO 9999:2016, 12 36 18 Assistive products for lifting persons

Classification: MDR Class 1

01/06/2021

Place and Date



Simon Claridge, CEO



Exclusively distributed by



1300 133 120 | aidacare.com.au
sales@aidacare.com.au



EC	REP	WINNCARE France 4, Le Pas du Château - 85670 Saint-Paul-Mont- Penit - France Tél : +33 (0)2 51 98 55 64 www.winncare.fr
----	-----	--

