

PRIDE[®]
MOBILITY
LIVE YOUR BEST[®]

GO *Litestream*[®]
CARBON



OWNER'S MANUAL

PRIDE[®]
MOBILITY
LIVE YOUR BEST[®]



Pride Mobility Products Australia Pty. Ltd.
20-24 Apollo Drive, Hallam, Victoria, 3803, Australia

CONTENTS

1.INTRODUCTION -----	2
2.PRECAUTIONS FOR SAFE USE -----	3
3.PERFORMANCE AND STRUCTURE -----	15
4.TECHNICAL FEATURES -----	17
5.ASSEMBLY/FOLDING/ADJUSTING -----	18
6.USE AND OPERATION -----	22
7.FAULT ANALYSIS AND TROUBLESHOOTING -----	26
8.SAFETY PROTECTION DEVICE AND ACCIDENT HANDLING -----	26
9.MAINTENENCE AND REPAIR -----	26-28
10.TRANSPORTATION AND STORAGE -----	28

1.INTRODUCTION

Read and follow all instructions, warnings, and notes in this manual before attempting to operate your power wheelchair for the first time. If there is any information in this manual which you do not understand, or if you require additional assistance for assembly or operation, please contact with your authorized local dealer. To use your product safely depends on whether you strictly follow the warnings, attentions and operating instructions in this manual. The company shall not be responsible for any injury or damage caused by non-compliance with the warnings, attentions and operating instructions. These symbols below in this manual are used to identify warnings and important information. All of them are very important to your safety. It is strongly recommended that you should read and understand them completely.



Warning! Failure to heed the warnings in the manual may result in personal injury.



Attention! Failure to heed the attentions in the manual may result in damage to the wheelchair.

This product integrates advanced technology with modern style. Especially, its structure for quick folding is very convenient for you to store or place at the trunk of your vehicle while traveling. We are certain that the design features, excellent performance and trouble-free operation of this product will ensure your daily life more convenient.

This power wheelchair is suitable for the disabled and aged with normal thinking and difficulty in moving.

This power wheelchair is of outdoor type, suitable for the use indoor and flat path near buildings, but not on grass, gravel roads, large slopes or motorway, and also not in rain or snow.

2. PRECAUTIONS FOR SAFE USE

2.1 Expiration Date

This power wheelchair is energy, non-asepsis and reusable product.

The safe and period of validity for wheelchair on the clinical use not only depends on its structural strength, but also on the user usage and use of the product environment, user habits, whether in accordance with the periodic maintenance, and other factors .

Our products are valid from the date of production for 7 years.

2.2 Instructions before use

2.2.1 If not completely read and understand the user manual, please do not drive.

2.2.2 The maximum loading capacity is shown in the parameter table for technical features. Please do not overload driving. And it is single use, please do not carry passengers.

2.2.3 Please do not drive after drunk or too tired.

2.2.4 Please do not drive at night or in the case of an unclear line of sight.

2.2.5 Please self-check before driving and refer to the manual section "adjusting" and "Practice before operation " if driving for the first time.

2.2.6 This wheelchair is not waterproof, do not expose in rain and snow as well as driving in rain or snow.

2.3 Attention in use

2.3.1 This power wheelchair can drive on a good flat surface; do not drive on muddy, rugged, soft, narrow, icy road, bad roads such as dangerous roads without guardrails or waterways.

2.3.2 This power wheelchair has the certain ability of groove obstacle , at this time you should reduce the speed and travel slowly.

2.3.3 This power wheelchair has the certain climbing ability, the climbing angle is $\geq 6^\circ$, but no more than 10° .

2.3.4 Please avoid driving in the crowds, traffic flows and other places with heavy traffic.

2.3.5 Please ensure that the control system is firmly installed, the joystick is vertical, correctly positioned. Please sit well and buckle up in time, keep your head as back as possible, lean against the backrest in case out of control due to the dump.

2.3.6 Press the on/off button, firstly check if the current fastest speed setting is appropriate for yourself operating proficiency, or it should be adjusted for safety;

We recommend to drive slowly at the beginning for each use, and gradually accelerate.

2.4 Electromagnetic interference (EMI)

Electromagnetic interference is from external electromagnetic wave energy (like radios, TV transmission stations, CB radio waves, and garage door starters, radio phones, etc.). Electromagnetic interference may affect the control system of the power wheelchair. Some interference may lead to the brake failure, power on automatically, or steering failure, also may lead to the permanent damages to the control systems.

Below cables information are provided for EMC reference.

Cable	Max. cable length, Shielded/unshielded		Number	Cable classification
AC Power Line	1.8m	shielded	1 Set	AC Power
DC Power Line	1.2m	shielded	1 Set	DC Power

Important information regarding Electro Magnetic Compatibility (EMC)

This electrical medical equipment needs special precautions regarding EMC and put into service according to the EMC information provided in the user manual; The equipment conforms to this IEC 60601-1-2:2014 standard for both immunity and emissions. Nevertheless, special precautions need to be observed:

The equipment with ESSENTIAL PERFORMANCE/Following ESSENTIAL PERFORMANCE is intended used in Home healthcare environment.

ESSENTIAL PERFORMANCE:

The power wheelchair can work normally without moving out of control, and the speed change is not more than $\pm 20\%$.

WARNING: Use of this equipment adjacent to or stacked with other equipment should be avoided because it could result in improper operation. If such use is necessary, this equipment and the other equipment should be observed to verify that they are operating normally”.

The use of accessories, transducers and cables other than those specified or provided by the manufacturer of this equipment could result in increased electromagnetic emissions or decreased electromagnetic immunity of this equipment and result in improper operation.

WARNING: Portable RF communications equipment (including peripherals such as antenna cables and external antennas) should be used no closer than 30 cm (12 inches) to any part of the W5907, including cables specified by the manufacturer. Otherwise, degradation of the performance of this equipment could result.”

WARNING: If the use location is near (e.g. less than 1.5 km from) AM, FM or TV broadcast antennas, before using this equipment, it should be observed to verify that it is operating normally to assure that the equipment remains safe with regard to electromagnetic disturbances throughout the expected service life.

When the AC input voltage is interrupted, the equipment will stop battery charging and if the power supply restored, it could be recovered automatically, this degradation could be accepted because it will not lead to unacceptable risks and it will not result in the loss of basic safety or essential performance.

EMI Compliance Table (Table 1)

Table 1 - Emission

Phenomenon	Compliance	Electromagnetic environment
RF emissions	CISPR 11 Group 1, Class B	Home healthcare environment
Harmonic distortion	IEC 61000-3-2 Class A	Home healthcare environment
Voltage fluctuations and flicker	IEC 61000-3-3Compliance	Home healthcare environment

EMS Compliance Table (Table 2-5)

Table 2 - Enclosure Port

Phenomenon	Basic EMC standard	Immunity test levels
		Home healthcare environment
Electrostatic Discharge	IEC 61000-4-2	±8 kV contact ±2kV, ±4kV, ±8kV, ±15kV air
Radiated RF EM field	IEC 61000-4-3	20V/m 26MHz-2.5GHz 80% AM at 1kHz 10V/m 80MHz-2.7GHz 80% AM at 1kHz
Proximity fields from RF wireless communications equipment	IEC 61000-4-3	Refer to table 3
Rated power frequency magnetic fields	IEC 61000-4-8	30A/m 50Hz or 60Hz

Table 3 – Proximity fields from RF wireless communications equipment

Test frequency (MHz)	Band (MHz)	Immunity test levels
		Home healthcare environment
385	380-390	Pulse modulation 18Hz, 27V/m
450	430-470	FM, ±5kHz deviation, 1kHz sine, 28V/m
710	704-787	Pulse modulation 217Hz, 9V/m
745		
780		
810		
870	800-960	Pulse modulation 18Hz, 28V/m
930	1700-1990	Pulse modulation 217Hz, 28V/m
1720		
1845		
1970		
2450	2400-2570	Pulse modulation 217Hz, 28V/m
5240	5100-5800	Pulse modulation 217Hz, 9V/m
5500		
5785		

Table 4 – Input a.c. power Port

Phenomenon	Basic EMC standard	Immunity test levels
		Home healthcare environment
Electrical fast transients/burst	IEC 61000-4-4	±2 kV 100kHz repetition frequency
Surges Line-to-line	IEC 61000-4-5	±0.5 kV, ±1 kV
Conducted disturbances induced by RF fields	IEC 61000-4-6	3V, 0.15MHz-80MHz 6V in ISM bands and amateur radio bands between 0.15MHz and 80MHz 80%AM at 1kHz
Voltage dips	IEC 61000-4-11	0% UT; 0.5 cycle At 0°, 45°, 90°, 135°, 180°, 225°, 270° and 315°
		0% UT; 1 cycle and 70% UT; 25/30 cycles Single phase: at 0°
Voltage interruptions	IEC 61000-4-11	0% UT; 250/300 cycles UT=rated input voltage

Table 5 – Signal input/output parts Port

Phenomenon	Basic EMC standard	Immunity test levels
		Home healthcare environment
Electrostatic Discharge	IEC 61000-4-2	±8 kV contact ±2kV, ±4kV, ±8kV, ±15kV air







WARNING! Please observe the WARNINGS below to avoid any damage or injury resulted from improper use of your wheelchair. The wheelchair user is responsible for taking proper safety measures. We will not be liable for personal injury and/or product damage resulted from improper use of the wheelchair. Obey all local pedestrian traffic rules. It may be difficult for others to see you when you are seated on your wheelchair. Wait until your path is clear of traffic, and then proceed with extreme ATTENTION. Use of safety devices such as reflectors, reflective clothing, lights and safety symbols is very important for your safety while driving.

 **WARNING! NEVER** try a new manoeuvre on your own, out of the manual stated.

 **WARNING!** Do not use the wheelchair other than for its original purpose. Avoid any use, such as weight training, sports and athletics, hauling, moving or towing anything, that may lead to safety hazards and undue stress on the wheelchair.

 **WARNING!** We strongly recommend that you do not smoke cigarettes while seated on your wheelchair. You must adhere to the following safety guidelines if you decide to do so: Keep ashtrays a safe distance from the seat cushions. Always make sure cigarettes are completely extinguished before disposal.

 **WARNING!** Before getting on/off the wheelchair, you should sit behind as far as possible to avoid injury caused by overturning.
 **WARNING!** Avoid holding on armrest, which will cause rollovers and injuries.
 **WARNING!** Avoid concentrating your weight on the footrest. Otherwise, it will cause overturning and personal injury.

 **WARNING!** Do not use the wheelchair in manual mode without accompanying person, which may cause personal injury.
 **WARNING!** When sitting in the wheelchair, please do not move by yourself, which may cause personal injury. Ask your accompanying person for help if necessary.

 **WARNING!** Do not make any alterations to the wheelchair without permission. Adding accessories may change some of the wheelchair specifications such as total weight, size, or center of gravity. Please note that some changes may damage things around you.

 **WARNING!** Please do not change your seat specification. Do not place any cushions or pillows on the seat, which will result in the user falling out from the wheelchair caused by instability of seat.









 **WARNING!** Be extremely careful when using oxygen near electrical circuits or combustible materials. Please contact your oxygen supplier for information on the safe use of oxygen.







 **Attention!** Do not change the controller Settings. Please ask your service provider to check it if you notice any changes in your ability to control the wheelchair.

 **WARNING!** During the operation, the wheelchair may suddenly stop at any time. Do not operate the wheelchair if it is abnormal or irregular.

 **WARNING!** To prevent the wheelchair from losing control and moving on its own, do not place the wheelchair in manual mode on any inclined plane.

 **WARNING!** If you expect to sit in a fixed position for a long time, turn off the power to prevent accidental movement of the wheelchair.

-  **WARNING!** Avoid any accessories that may interfere with the operation of the joystick. Otherwise, it will cause the wheelchair to move unexpectedly.
-  **WARNING!** Keep yourself, clothing and other objects away from the wheel while the wheelchair is moving. Do not drag anything behind the wheelchair while driving.
-  **Attention!** Do not connect any other devices to the electronic system or turn on any other devices with the wheelchair battery.
-  **Attention!** When disconnecting wiring harness, please hold the terminal in case damage to it. Do not pull the wiring harness directly.
-  **WARNING!** Keep all charger connector terminals clean and dry, away from damp sources to prevent damage to electrical system and personal injury.
-  **Attention!** The storage temperature of wheelchair is 0°C~50°C. Long term storage in low or high temperature environment will damage its function.
-  **Attention!** Always check electrical components for corrosion. Check all brakes for looseness, wear or damage. Check wiring harnesses and terminal posts for breakage. If necessary, please do the replacement.
-  **Attention!** Please ensure the safety of wheelchairs and batteries during transportation. Never transport wheelchairs or batteries with combustible materials.

-  **Attention!** Do not connect the cable directly to the battery terminal/clip for charging.
-  **Attention!** Do not remove the fuse from the battery harness. If the fuse is damaged, please contact your supplier for replacement.
-  **WARNING!** Do not operate the wheelchair with dead battery. You might get trapped.
WARNING! Please slow down when turning, don't make sharp turns, keep the center of gravity stable when turning. To prevent rollover, do not move the center of gravity in the opposite direction when turning.
WARNING! Drive straight up the slope when climbing. Both front wheels should land at the same time. To reduce the possibility of overturning, do not make an angle with the slope; do not make the wheel on one side or the side of the wheelchair to go up the slope first. Be particularly careful when climbing any slopes.
-  **WARNING!** Do not drive on potentially dangerous roads or slopes, including but not limited to roads covered with snow, ice, cut grass, or wet leaves.
-  **WARNING!** Please drive down a slope at the minimum speed. If the descent speed is faster than expected, release the joystick lever to stop the wheelchair, and then press the lever lightly to control the descent speed.
-  **WARNING!** Do not place the wheelchair in the front seat of vehicle during transportation. Otherwise, it may move and disturb the driver.



Attention! Please contact your service provider if any accessories of seat unit become loose; Please replace the worn or damaged parts immediately.



WARNING!The recommended maximum climbing angle (see parameter table) was tested in a controlled environment.The climbing ability of your wheelchair is affected by factors such as your weight, the speed of your wheelchair, and the angle at which you approach the slope.



WARNING! Reversing is only possible on flat roads. When reversing, please operate smoothly at low speed. Please stop frequently and check to make sure there are no obstacles on the road. To prevent rollover, do not tilt down or backward along the slope.



WARNING!When sitting in a wheelchair, avoid any position or movement that can change your center of gravity. This may cause the wheelchair to tilt.
WARNING! Do not put all the weight on one side of the wheelchair armrest, such use may cause the wheelchair to tilt.



WARNING!Do not put your hands above the seat or tilt your body. This may damage the backrest and cause you to fall down.



WARNING! Even if your wheelchair can cross high obstacles, we recommend that you do not try to cross the specified height. Such operations may cause the wheelchair to be unstable,even rollover and cause severe personal injury.If you have any concerns about safely crossing obstacles, please ask for help. Please pay attention to your operating skills and personal restrictions. You may need to remove or cover the sills and install ramps at exits and entrances.



WARNING! Do not attempt to climb over obstacles on slopes.
WARNING!Do not rely on a wheel to get over obstacles.



WARNING!Never operate the wheelchair near railroad tracks or crossings.



WARNING! Do not drive the wheelchair along the edge of a stream, lake or sea.
Please do not drive the wheelchair across the water.



WARNING!Do not expose wheelchair to open flames.



ATTENTION! Keep your wheelchair in a dry and clean environment.Don't take the wheelchair to shower, bath, pool or sauna. Rain, snow, salt, fog / spray conditions and frozen / smooth surfaces can cause wheelchair screws and some fixtures to rust untimely.



ATTENTION! Avoid prolonged exposure to excessively hot and cold environments; it may damage the cushioned and non-cushioned parts of the wheelchair as well as the battery and battery components.



ATTENTION! Do not drag the wheelchair. Dragging may exceed its own speed threshold,causing damage to key parts of the wheelchair.





ATTENTION ! Be extremely careful when moving an idle wheelchair up and down the stairs.The wheelchair must be folded, requiring the participation of physically capable people.

 **WARNING!** Do not cross stairs or escalators with the wheelchair.

 **WARNING!** Do not sit on a wheelchair while it is in any transport vehicles.

 **WARNING!** For safer handling: Always keep the power off before moving. Failure to do so may result in touching the joystick and causing the wheelchair to move unexpectedly. Make sure the brakes are locked so to prevent the wheelchair from moving during handling. This wheelchair could be driven into the elevator, while you must turn off the power and sit firmly to ensure that the wheelchair will not move after entering the elevator.

 **WARNING!** Please consult your healthcare professionals routinely to ensure there are no health or physical conditions that may limit or impair your ability to safely operate your wheelchair. Consult your physician if you are taking prescription or over-the-counter medication or if you have any physical limitations. Some medications and physical limitations may impair your ability to safely operate your wheelchair.

 **WARNING!** Do not operate your wheelchair while you are under the influence of alcohol, as this can impair your ability to safely operate your wheelchair.
 **WARNING!** Every wheelchair is different. Take the time to learn it before your driving.
WARNING! BE AWARE that becoming a capable and safe wheelchair operator will take time and practice.

 **WARNING!** To ensure your safety, please read and understand this manual. You must be on high alertness when driving any wheelchair to ensure safety.

WARNING! Radio wave sources, such as radio stations, television stations, amateur radio transmissions, two-way radios and mobile phones can affect wheelchair control.
The following **WARNINGS** should reduce the possibility of severe injury due to accidental braking or movement of the power wheelchair:
 1. Do not turn on portable personal communication devices, such as citizen band (CB) radios and mobile phones when the power wheelchair is powered on;
2. Pay attention to nearby transmitters, such as radio or television stations, and try to avoid approaching them.
3. In the event of unexpected movement or brake release, the power wheelchair should be turned off as soon as possible under safe conditions;
4. Please note that adding accessories or parts, or modifying power wheelchairs may make it more susceptible to interference from radio wave sources (note: there is no easy way to assess the influences of above modifications on the wheelchair's overall immunity from radio wave sources); and report to the power wheelchair manufacturer of all accidents of unexpected movement or brake release, and pay attention to nearby radio sources and other important information.

 **Attention!** Please return the discarded batteries, controllers, motors, etc. to the supplier or manufacturer for disposal to avoid environmental pollution.

3.PERFORMANCE AND STRUCTURE

3.1 Product Structure

The wheelchair is mainly composed of front wheel, drive wheel, frame, controller, motor and drive devices, armrest, push-handle, backrest, seat cushion, pedal, battery case and charger. The structural diagram is as below

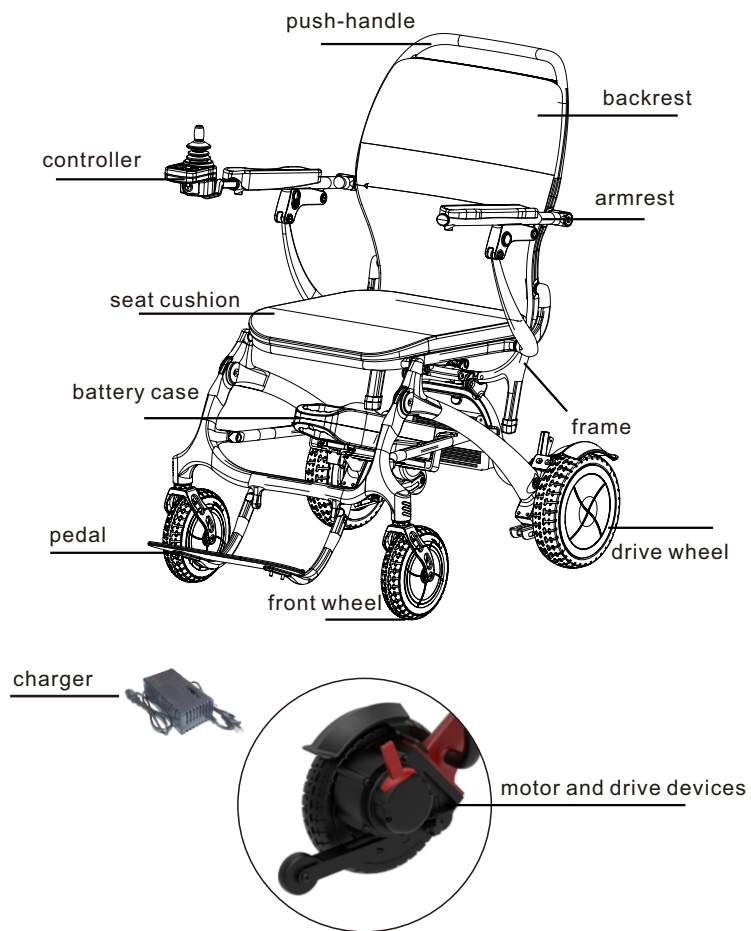

3.2 Electric diagram of power wheelchair

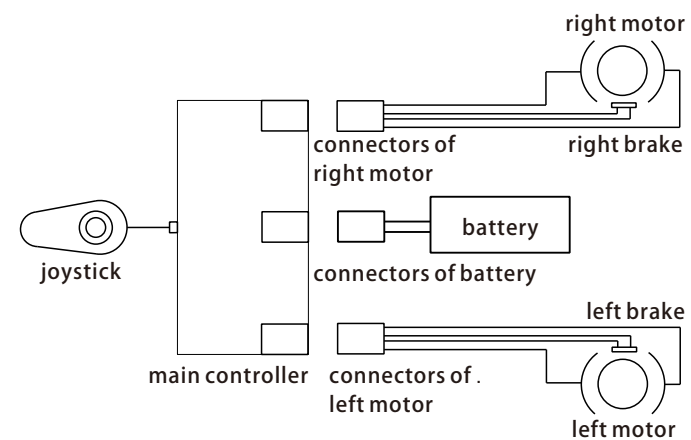

3.3 Product software version

The controller version of W5905 power wheelchair is V1.8

4. TECHNICAL FEATU

The main Performance Parameter of Power Wheelchair

Overall dimensions(L*W*H)	930mmX577mmX930mm
Folded Length	325mm
Folded Width	577mm
Folded Height	790mm
Effective Seat Depth	420mm
Seat Width	388mm
Effective Seat Width	480mm
Front Seat Surface Height	475mm
Back Height	464mm
Distance from Foot Care to Seat	425mm
Angle from Foot to Seat Surface	106°
Armrest Height	254mm
Armrest Front Position	368mm
Axis Horizontal Shift	80mm
Seat Horizontal Angle	5°
Back Angle	16°
Net Weight of Wheelchair	17Kg
Maximum Over the Obstacle Height	40mm
Maximum Speed	6km/h
Braking Distance on Horizontal Road	≤1500mm
Minimum Turning Radius	≤1200mm
Maximum Load Capacity	136kg
Driving Range	15km
Climbing Ability	≥9°
Maximum Climbing Degree	8°
Static Stability	9°
Dynamic Stability	≥6°
Motor Model	24V/250W*2
Lithium Battery Specification	12Ah
Maximum Output Current of Controller	35A
Maximum Output Current of Charger	2A
Front Wheel Specification	External Diameter 178mm
Rear Wheel Specifications	External Diameter 216mm

5. Assembling, Folding and Adjusting.

5.1 Assembling.

Open the packaging box, take out the whole wheelchair, and remove the protective cushion. Firstly open the pedals forward, take out the battery and insert it to the battery rail to the end, when you hear "click", it indicates the battery is installed in place(Fig. 1). Then hold the backrest with one hand and hold the seat with another hand to pull the wheelchair forward and backward. When you hear "click", it indicates that the latch has been stuck into the locking pin (Fig. 2), and the wheelchair has been unfolded. (Fig. 3)

WARNING! When inserting the battery, make sure that the battery fixed clip has been stuck the battery to prevent the battery slip off. If it is difficult to insert the fixing clip into the bottom, you can pull the fixing clip open by hand, then insert the battery into the bottom and let the fixing clip bounce back into the fixing slot to ensure that the battery is fixed.

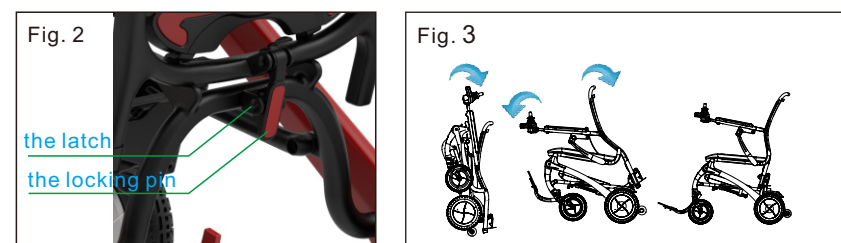
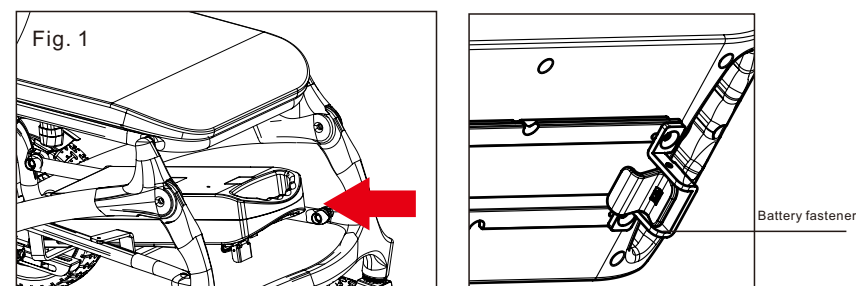

WARNING! After unfolding the wheelchair, it is necessary to check whether the latch has been stuck into the locking pin. And then you can sit on it only after the latch is fixed. Otherwise, it will damage the wheelchair and cause personal injury.

5.2 Adjusting.

5.2.1 Joystick Installation and Adjusting

The joystick can be adjusted to most comfortable position according to the user's specific situation. When adjusting it, please loose the knob of the armrest and then the joystick shall be stretched. When stretched at your most comfortable position, the joystick shall be firmly locked after the knob tightened.(Fig.4).

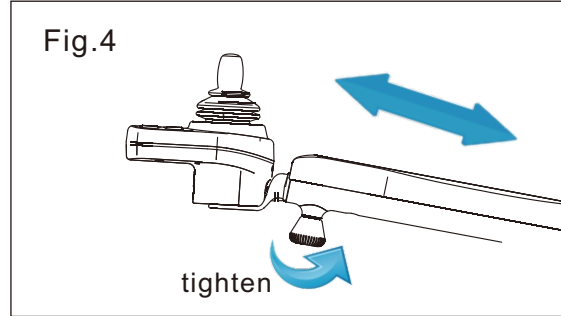

5.2.2 Anti-tipper Instruction

Anti-tipper is a safety device to prevent the wheelchair from turning over when driving on the slope(Fig.5).

Adjusting Anti-tipper

Anti-tipper is a safety device to prevent the wheelchair from turning over when driving on the slope(Fig.A). When you only need to use on indoor flat surfaces, retract the tilting wheel holder inwards. When need to drive on a slope, you must extend the anti-tipper to the outermost gear. When adjusting, just press down the latch of anti-tipper holder by hand ① that can move inward or outward ②. Put the latch into the position limit hole (3)when the position is confirmed.

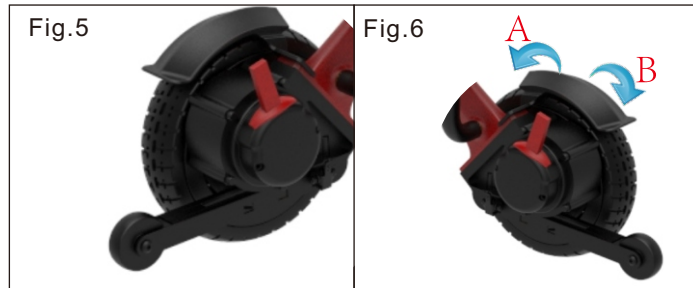

5.2.3 Adjusting brake lever

There is a set of brake lever attached with driving motor. When the lever is pushed at location A, the wheelchair will be in electric mode, which will only be operated by power. When the lever at location B, the wheelchair will be in manual mode, which will only be pushed by hand.(Fig. 6)

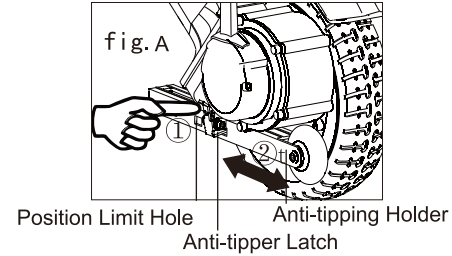

WARNING! When the wheelchair is in manual mode, do not use your wheelchair unless getting help from your assistant. Otherwise, it may result in personal injury. Do not set your wheelchair in manual mode when it is on an incline. Otherwise, the wheelchair could be out of control to roll down by itself, and result in personal injury.

5.2.4 Adjusting Armrests

For the convenience of getting on/off the wheelchair for people who have trouble with walking, the armrest of this product can be flipped up. To flip up the armrest, just press the lock button under the armrest, flipping upward meanwhile(Fig.7). When to flip down the armrest, just press downward the armrest, when you hear the "click" sound, indicating that the lock button has stuck into the armrest. The armrest is reset now.

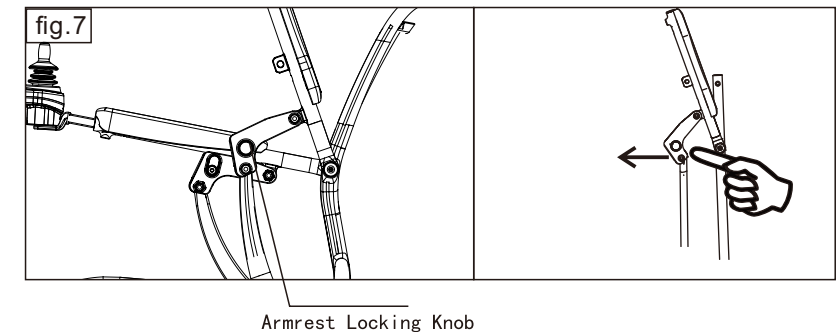

5.3 Folding

If the wheelchair needs to be folded, please pull up the latch at the rear of the wheelchair body, meanwhile push forward the backrest, the wheelchair body latch will detach the fixed pin(Fig.8). Then push the backrest forward with one hand and flip up the seat cushion with another hand, then the wheelchair could be folded. With the wheelchair body folded in place, flip up the footrest, the wheelchair can be placed standing up. (Fig.9)

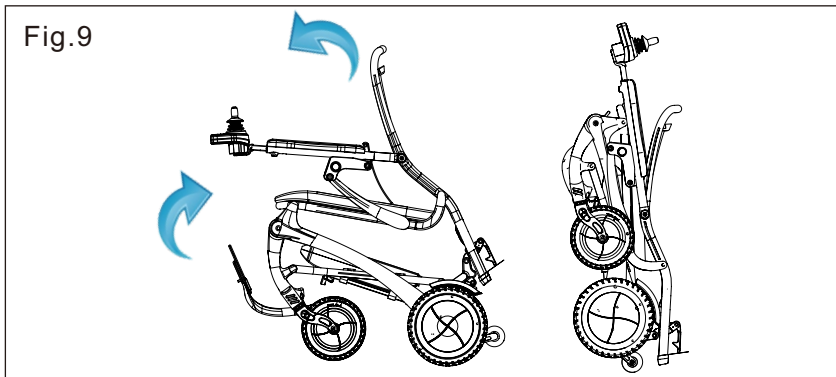
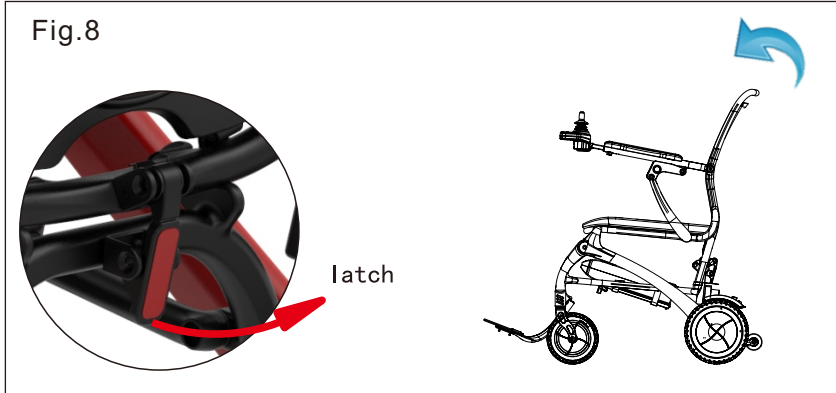

6. Use and Operation

6.1 Use

6.1.1 Joystick: an indispensable electric device, all the electronic components to control the wheelchair are integrated to the joystick. (Fig. 10) The joystick is usually installed on one of the armrest and is connected together to the power box with motors and batteries.

- **Power Switch:** the switch to supply power to the control system, the power supply to the wheelchair motor after go through the switch. Do not stop the wheelchair driving by using the switch unless there is an emergency, otherwise it will shorten the life of the wheelchair drive components.
- **Joystick Lever:** The main function of the joystick is to control the direction and speed of wheelchair. The further the joystick is pushed from its central position, the faster the wheelchair moves, when it is released, it will automatically reset and brake.
- **Horn Button:** Press this button, the horn will sound.
- **Speed up Button and Speed down Button:** After turning on the power, the speed indicator displays the current maximum driving speed, and will increase or decrease by one bar with each press on the speed up button or speed down button. The quantity of displayed bars represents the current maximum speed. The range could be adjusted by the user.
- **Charger Socket:** this socket can be used only for wheelchair charging. Do not use the socket to supply power to any other electrical device. Otherwise, it may damage the wheelchair's control system or its E.M.C (electromagnetic compatibility) performance.(Fig.11)

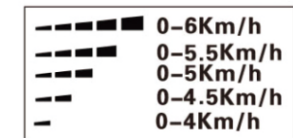
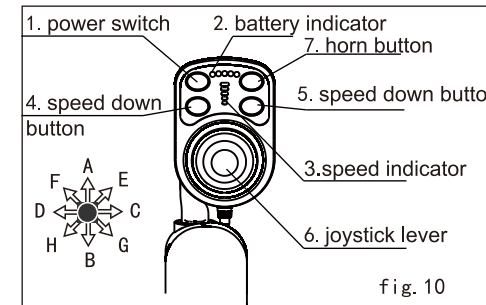

! WARNING! Avoid any accessories that may interfere the operation of joystick. Otherwise, the wheelchair may move accidentally.

! WARNING! If your wheelchair move accidentally, please release the joystick at once ,the wheelchair will stop by itself.

6.1.2 Usage of Battery

Fully charge the new battery prior to its initial use. This brings the battery up to 90% of its peak performance level. Give the battery a full charge(The green LED on the charger lights) after every use and operate your wheelchair again, the batteries will perform at over 90% of their potential. After four or five charging cycles, the battery utilization rate is close to 100%, extending the battery lifespan.

After battery failure, please be sure to buy new batteries and replace them as required, and the old ones must be returned to the supplier for disposal to prevent environmental pollution.

In the case of not using, it is recommended to charge the battery every two months, and use it for more than 20 minutes, which can extend the life of the battery. Batteries that have been used for more than three years shall be returned to the factory for overhaul or replacement.

It is forbidden to charge indoors, and pay attention to keep away from fire and heat source when charging. Please put the product in the open, clean, dry and ventilated place with no inflammable, explosive or chemical substances around. Batteries replaced or scrapped shall be recovered and disposed of in accordance with local laws.

6.1.3 Usage of Charger

Battery charger is an important component of wheelchair. The wheelchair can reach the optimal state by simple and fast charging with this charger.

Use charger to charge the battery

- Make sure the controller is turned off and the rechargeable battery is connected to the controller.
- Connect the three-pin metal plug of the charger to the three-hole interface of the controller(Fig.14)
- Plug the other end plug of charger into a standard socket. The blue light is on when charging and the green light is on when the battery is fully charged.
- After battery is fully charged, remove the power line and charger.

6.1.4 Charging the battery off the wheelchair

Release the buckle which holds the battery pack underneath the seat; hold the handle of battery pack and pull it out forward (Fig. 13)

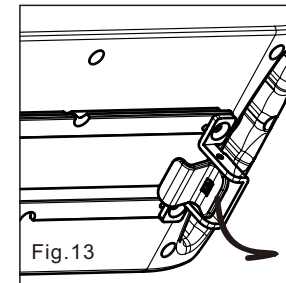

6.1.5 Two Charging Methods

Connect the input plug of charger to the standard power outlet and connect the output plug of charger to the controller socket for charging, or detach the battery for charging by connecting interface on the battery box.

Fig.14

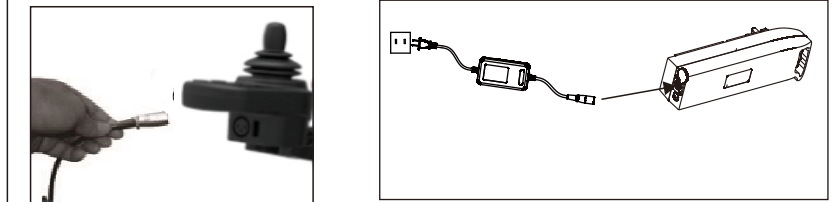

! WARNING! Please do not operate the wheelchair while charging.

6.1.7 Overload protector and undervoltage protector

This unit is designed for wheelchair safety by switching off and on a protective panel mounted on a lithium battery. It will immediately cut off power supply if the motor is overloaded or the voltage is too low so as to protect motors and electrical components from damage. To restore the protector function, use the charger to charge the wheelchairs or replug the battery connector. (Fig.16)

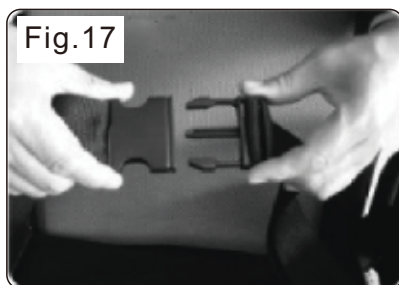

6.1.8 If no need to drive the wheelchair, release the joystick lever and the wheelchair will stop immediately.

6.1.9 Safety belt

For your safety, the safety belt must be fastened before you drive the wheelchair. you must fasten the seat belt when using wheelchairs (Fig.17)

6.2 Operation

6.2.1 Preparation before operation

- Do not turn on the power switch when sitting on the power wheelchair, and do turn off the power switch when get off from the wheelchair.
- Please fold the pedal first then hold the armrest to sit on the wheelchair; Do not get off the wheelchair by stepping on the pedal. Otherwise the wheelchair maybe turned over, which is dangerous.

6.2.2 Practice before operation

- Find a spacious place like square and have a assistant to help you practice until you have enough confidence to operate it.
- Be certain to shut down the power when you get on and off the chair, and set the speed control button to the speed you want.
- We recommend you set the lowest speed until you can operate the electric wheelchair skillfully.
- Practice stopping, moving forward and backward. Push the handle and move the Wheelchair anywhere you want.

6.2.3 Operation

Follow the pre-operation practice.

7. FAULT ANALYSIS AND TROUBLESHOOTING

For your convenience, this wheelchair is equipped with an automatic fault warning device. Once it is out of order, the controller panel will display the pattern and the horn will sound. You can find where the fault is according to the table below. If the fault persists after checking, please contact your service agent.

Beep 2+1	Communication failure	Check connection inside the joystick
Beep 2+2	Right motor failure	Check right motor or wire connection
Beep 2+3	Right brake error or cable connection poor	Check if the brake lever is in place & if the brake is damaged
Beep 2+4	Left motor failure	Check left motor or wire connection
Beep 2+5	Left brake error or cable connection poor	Check if the brake lever is in place & if the brake is damaged
Beep 2+6	Overcurrent	Check if the motor is locked or short circuit or if the joystick is damaged
Beep 2+7	Joystick lever failure	Check if the joystick lever works normally or the inside connection is loose
Beep 2+8	Joystick failure	Check with supplier for repair
Beep 2+9	Battery failure	Charge the battery, if still not work, replace a new battery with same specification

8. SAFETY PROTECTION DEVICE AND ACCIDENT HANDLING

8.1 Overload protector: Refer to instruction manual 6.1.7

8.2 Safety belt: Refer to instruction manual 6.1.9

8.3 Please release the joystick whenever there is a wheelchair fault, the wheelchair will be stopped.

9. MAINTENANCE AND REPAIR

9.1 Maintenance

Like other motorized vehicle, your power wheelchair also requires routine maintenance. Some checks can be performed by yourself, others you can ask for assistance from your service agent. Preventive maintenance is very important. If you follow the maintenance and checks in this section, your wheelchair will give you years of trouble-free operation. For any questions regarding the maintenance or operation of the wheelchair, please contact your dealer or our after-sales service dept.

9.1.1 Humidity

Your wheelchair, like most electrical and mechanical equipment, is susceptible to external conditions. In any case, the wheelchair should be avoided damp environment. Direct or prolonged exposure to water or dampness could cause the wheelchair to malfunction electronically and mechanically. Water can cause electrical components to corrode.

9.1.2 Temperature

- Some parts of your wheelchair are susceptible to temperature.
- Too high or too low temperature will affect the performance of the wheelchair.

9.1.3 Regular guidance

- Avoid knocking or hitting the control units.
- Avoid prolonged exposure of your wheelchair to extreme conditions, such as overheating, undercooling or moisture environment.
- Keep the controller clean.
- Check all connections, and ensure that they are all tight, secure and not corroded.
- If the battery indicator on the controller only shows red, indicating that the battery is low, it should be charged immediately.
- All wheel bearings are lubricated and sealed. No need to lubricate them.

9.1.4 Maintenance after use

- Turn off the power.
- Inhibit children and unconscious persons to use the wheelchair.
- Store the wheelchair in normal temperature to prevent deformation so that it keeps its performance for long period.
- Clean the wheelchair with a clear and soft cloth and dry it. Never use any chemicals to clean it. (to prevent deformation and discoloration).
- Remove the cloth cover of the seat rest to be washed if it is dirty, and then dry it for use.

9.1.5 Daily Checks

In order to keep the wheelchair always in good condition, you should check it before each use and keep weekly, monthly, semi-annual check. See the table below for the inspection items.

Inspection Items	At any time	Weekly	Monthly	Semi-annual
Wheel hubs, driving mechanism and fasteners			⊙	
Joystick function	⊙			
Brake	⊙			
Connecting lines		⊙		
Battery condition	⊙			
Tire condition			⊙	
Frame condition				⊙
Motor and driver condition				⊙
Front wheel steering and other functions		⊙		
Cleanliness	⊙			

9.1.6 Cleaning

- Never wash your wheelchair with water or expose directly to water.
- Surface of wheelchair frame is coated with a protective coating. Therefore, it is very easy to wipe it clean with a damp cloth. Never use any chemicals to clean the vinylon seat and armrest, as they may cause the latter slip or chapped. You can use a damp cloth and neutral soapy water to clean them, and then dry thoroughly.

9.2 Repair

9.2.1 Users could repair or replace some spare parts like push handle, push handle cover which could be self-maintained or replaced under the instructions of after-sales service staff of our corporation or the dealers'.

9.2.2 Within the warranty, our corporation or the dealers will maintain or replace the faulted spare parts, like motor, battery, charger, controller, bearing, shaft sleeve, etc., due to material or manufacturing defects free of charge.

9.2.3 The spare parts like motor, controller, etc. which are confirmed by the after-sale staff or our corporation or our dealers' to be disassembled could be sent to our corporation or the dealers for maintenance.

9.2.4 Please contact your distributor or the after-sale service dept. of our corporation for any questions regarding the maintenance of power wheelchairs.



ATTENTION!

In order to ensure the quality of wheelchair, during the maintenance, if any consumable parts such as battery, wheels, joystick, motor/actuator and charger need to be replaced, please contact this company or dealer, replacing the original parts of same model and specification. The repair should be carried out at the professional maintenance room of our corporation or the dealer(s).

10. TRANSPORTATION AND STORAGE

Transportation

You can load and transport according to the shipping marks and graphics on cartons. For details, see the attachment.

Storage

Your wheelchair should be stored in a clean indoor environment with relative humidity ≤80% , temperature between 0~50° , good ventilation and free from corrosive gas. Remove the battery from the wheelchair prior to storage. Otherwise, the frame may rust and the electronics may be damaged.