

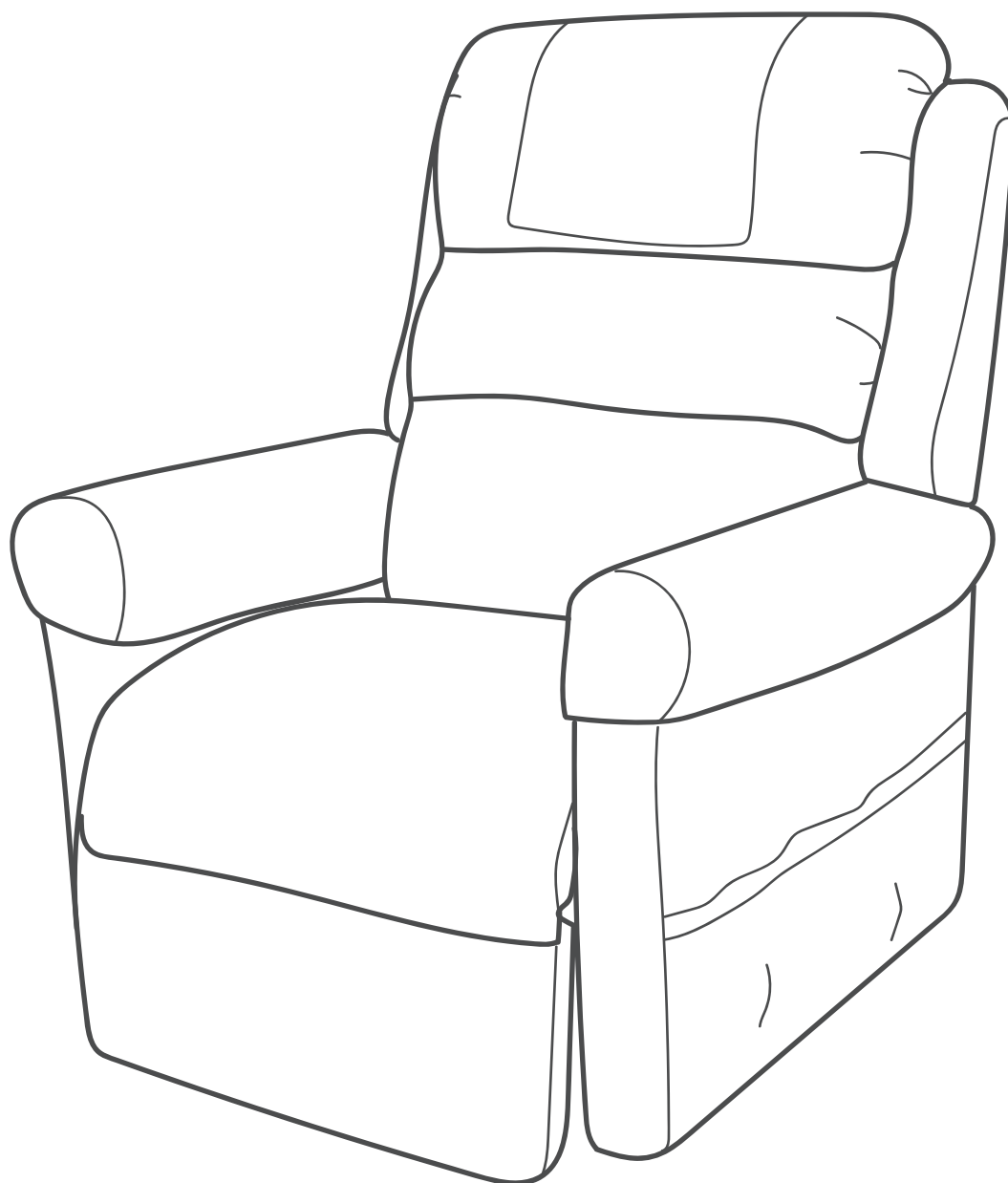

LIFT RECLINE CHAIRS

Porto | Raphael | Maui | Montana | Oregon | Idaho | Signature | Matisse |
Renoir | Montana HD | Gabriel

USER MANUAL



Congratulations and thank you for choosing an
Aspire Lift Recline chair.

This product has been designed to offer the maximum in comfort,
safety and lightweight portability. Aspire Lift Recline chair are suitable
for indoor and limited outdoor use.



**It is important that you read this user manual carefully before using
your new Lift Recline chair.**

TABLE OF CONTENTS

1. Symbols used in this manual _____	4
2. Symbols used on the product _____	4
3. Label information _____	5
4. Introduction _____	6
5. Purchaser's agreement _____	6
6. General Guidelines _____	7
7. Your lift chair _____	10
8. Assembly/Disassembly _____	13
9. Operation _____	18
10. Troubleshooting _____	25
11. Care and Maintenance _____	26
12. Warranty _____	28
13. Specifications _____	29
14. Appendix A _____	30

1. SYMBOLS USED IN THIS MANUAL









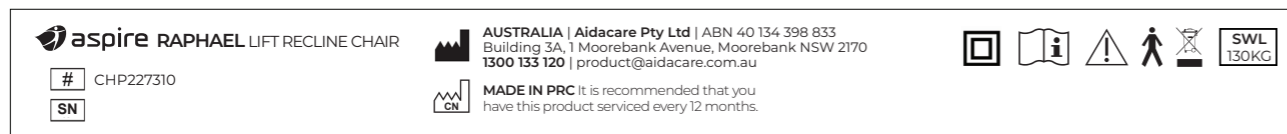

The symbols below are used throughout this user manual and on the product to identify warnings and important information. It is very important for you to read them and understand them completely.

-  **WARNING!** Indicates a potentially hazardous condition/situation. Failure to follow designated procedures can cause either personal injury, component damage or malfunction. On the product, this icon is represented as a black symbol on a white triangle with a black border.
-  **ALWAYS!** These actions should be performed as specified. Failure to perform mandatory actions can cause personal injury and/or equipment damage. On the product, this icon is represented as a white infinity symbol on a black dot with a white border.
-  **DO NOT!** These actions are prohibited. These actions should not be performed at any time or in any circumstances. Performing a prohibited action can cause personal injury and/or equipment damage. On the product, this icon is represented as a white symbol with a black circle and black slash.

2. SYMBOLS USED ON THE PRODUCT

Stickers shown are not to scale.



-  Product Code
-  Serial Number
-  Country of Manufacture
-  Manufacturer
-  Includes electronic components and should not be mixed with general household waste
-  Safe Working Load
-  Read User Manual
-  Caution
-  Type B as per IEC60601-1
-  Class 2 Electrical Equipment

3. LABEL INFORMATION

PRODUCT SAFETY SYMBOLS

The symbols below represent labels used on the product to identify warnings, mandatory actions and prohibited actions. It is very important for you to read and understand these symbols completely. Do not remove these labels from your product. Please note that not all of the symbols may be used on your lift chair model.

-  Pinch/Crush Points Hazard! Do not place objects or appendages in the path of moving parts.
-  Electrical Hazard
-  Read and follow the information in the owner's manual.
-  Maximum weight capacity
-  Do not connect an extension lead to the AC/DC converter or the battery charger.
-  Removal of grounding prong can create electrical hazard. If necessary, properly install an approved 3-pronged adapter to an electrical outlet having 2-pronged plug access.
-  Properly dispose of all electronic components, including the external transformer, hand control, batteries, actuator motors and wiring. Contact your authorised Aspire Dealer for more information.
-  Do not place objects under the lift chair. Make sure the area is clear of obstructions, including pets and small children during operation.
-  Do not place objects under the footrest when the lift chair is in the fully reclined position. Make sure area is clear of obstructions, including pets and small children during operation.
-  Do not cover or place the external transformer under the riser recliner. Keep in an open, well-ventilated area free from foreign material and away from possible pinch points.
-  Battery Door Location
-  Indoor Use Only. Avoid exposure to rain, snow, ice, salt or standing water. Maintain and store in a clean and dry environment.
-  Class II Equipment
-  Green LED indicates power to the unit is on. Not applicable to all models.
-  Degree of protection against electric shock.
-  This product has been tested and complies to IEC 60601-1-2.

4. INTRODUCTION

SAFETY

CONGRATULATIONS on purchasing your Aspire Lift Chair. The product you have purchased combines state-of-the-art components with **safety**, comfort and styling in mind. We are confident the design features will provide you with the conveniences you expect during your daily activities. Understanding how to **safely** operate and care for this product should bring you years of trouble-free operation and service.

Read and follow all instructions, warnings and notes in this manual and all other accompanying literature before attempting to operate this product for the first time. In addition, your **safety** depends upon you, as well as your dealer, carer or healthcare professional in using good judgement.

If there is any information in this manual which you do not understand, or if you require additional assistance for setup or operation, please contact your authorised Aspire Dealer. **Failure to follow the instructions, warnings and notes in this manual and those located on your Aspire product can result in personal injury or product damage and will void the Aspire product warranty.**

5. PURCHASER'S AGREEMENT

By accepting delivery of your lift recline chair, you agree neither to change, alter or modify the product or remove or render inoperable or unsafe any guards, shields or other safety features; nor fail, refuse or neglect to install any retrofit kits that may be provided by **Aidacare** or your Aspire Dealer from time to time to enhance or preserve the safe use of this product.

Please feel free to contact us at the address below:

AUSTRALIA:

AIDACARE PTY LTD

Building 3A, 1 Moorebank Avenue,
Moorebank NSW 2170

1300 133 120 | aidacare.com.au

NOTE: **Aidacare** reserves the right to update and, or, amend the contents of this user manual at all times. The latest version of this user manual can be downloaded at aspirecare.com.au or aidacare.co.uk

*Product colours and upholstery may vary from images provided for reference.

6. GENERAL GUIDELINES

Your lift chair is a state-of-the-art life-enhancement device designed to increase mobility. Please be aware that the final selection and purchasing decision regarding the type of lift chair to be used is the responsibility of you, the lift chair user, if capable of making such a decision, and/or your healthcare professional (i.e., medical doctor, allied health professional, therapist, etc).



MANDATORY! Read and follow the information provided in this owner's manual before attempting to operate your lift chair for the first time.

This product should be operated by an appropriately trained person. Along with completing product training with Aidacare or an authorised Aspire dealer, operators must have read and understand the user manual. The following information outlines important safety considerations when operating the lift recline chair

6.1 PRE-USE CHECKS

Before using your Aspire Lift Chair, check that it is working properly. Never use your chair if a fastening component is loose, a wheel or chair part does not function normally or upholstery parts are torn or undone

6.2 MODIFICATIONS

To prevent personal injury and/or damage; no part, feature or function of the Aspire Lift Chair should be modified, added to, removed or disabled. Unauthorised modifications could void the product warranty.

6.3 WEIGHT LIMITATIONS

Your lift chair is rated for maximum weight capacity. Refer to "Appendix A" for more information.

It should never be used to carry heavy objects or for any other purpose, other than maintaining a person whose weight does not exceed the maximum weight capacity.



MANDATORY! Users must be within the SWL capacity of the Aspire Lift Chair.

MANDATORY! Stay within the specified weight capacity of your lift chair. Failure to do so may result in injuries and/or product damage, Aidacare will not be held responsible for any such issues/ failures.

6.4 SHIPPING AND DELIVERY

Check that all components have arrived after delivery. If the Lift Chair is incomplete or shows signs of damage please contact your authorised Aspire dealer or place of purchase immediately.

6.5 PINCH/CRUSH HAZARDS

The scissor and lift mechanisms are labelled as pinch/crush point hazards on your lift chair. Keep clear of these areas and make sure the path of motion is unobstructed. See figure 3.1 for pinch/crush point locations.



MANDATORY! Read and follow the information provided in this owner's manual before attempting to operate your lift chair for the first time.

6.6 DEGREE OF PROTECTION/MODE OF OPERATION

- Class II equipment/Type B protection against electric shock
- Degree of protection against the ingress of solid/liquids—IPX0
- Mode of operation—Maximum Duty Cycle: 2 min. ON/18 min. OFF

6.7 ENVIRONMENT

Aspire Lift Recline Chairs are designed for indoor use in dry areas with level flooring. The chair should never be used on stairs or uneven surfaces.

6.8 MOTOR VEHICLE TRANSPORT

The Aspire Lift Chair is not designed to transport a user in a motor vehicle. If chair transportation is required, the user should sit in a designated vehicle seat with seatbelt and the Lift Chair should be stored in the cargo area.

Take care when manually handling the Lift Chair, use safe lifting practices when transferring in and out of a vehicle.



MANDATORY! Read and follow the information provided in this owner's manual before attempting to operate your lift chair for the first time.

6.9 ELECTROMAGNETIC AND RADIO FREQUENCY INTERFERENCE (EMI/RFI)



WARNING! Laboratory tests have shown that electromagnetic and radio frequency waves can have an adverse affect on the performance of electrically-powered devices, such as lift chairs.

Electromagnetic and Radio Frequency Interference can come from sources such as cellular phones, mobile two-way radios (such as walkie-talkies), radio stations, TV stations, amateur radio (HAM) transmitters, wireless computer links, Wifi, microwave signals, paging transmitters and medium-range mobile transceivers used by emergency vehicles. In some cases, these waves can cause unintended movement or damage to the control system of electrically-powered devices. The lift chair user can help prevent electromagnetic interference by maintaining a minimum distance between portable and mobile RF communications equipment. It is recommended that at least 3 metres (9 feet) of distance be maintained between the lift chair and any handheld equipment emitting 10 W or more of output power. Refer to the manufacturer's literature for the handheld device to determine the maximum output power of that device.

Every electrically-powered device has an immunity (or resistance) to EMI. The higher the immunity level, the greater the protection against EMI. Per EMC standards, this product has passed immunity testing and is rated as a Group 1, Class B product, meaning the lift chair uses RF energy only for its internal function. Therefore, its RF emissions are very low and are not likely to cause any interference in nearby electronic equipment making the lift chair suitable for use in all establishments, including domestic establishments and hospitals.



WARNING! Be aware that cell phones, two-way radios, laptops and other types of radio transmitters may cause unintended movement of your electrically-powered device due to EMI. Exercise caution when using any of these items while operating your lift chair.



WARNING! The addition of accessories or components to the lift chair can increase the susceptibility of the chair to EMI. Do not modify your lift chair in any way not authorised by Aidacare.

WARNING

WARNING! Your lift chair itself can disturb the performance of other electrical devices located nearby, such as alarm systems.

NOTE: If unintended motion occurs, discontinue use of the lift chair. Contact Aidacare to report the incident.

6.10 STORAGE AND OPERATION TEMPERATURES

If the chair is exposed to a heat source, such as a heater or sun rays, either directly or through a window pane, the temperature of the upholstery, metallic and plastic elements may increase and pose a burns risk to the user.



DO NOT smoke when sitting .

DO NOT sit on the chair's legrest, backrest or armrest. These are not designed as primary weight bearing surfaces and may sustain damage or create instability.

- Transportation or storage: -75°C/-104°F to 70°C/158°F
- Operation: 10°C/50°F to 40°C/104°F

7. YOUR LIFT CHAIR

BODY COMPONENTS

This section describes the features of your lift chair. Carefully review the function and location of each item described, and note that the illustrations and option locations shown in this manual may not reflect the type of lift chair that you own.

Figure 3.1 Lift Chair Main Components

Lift Mechanism: Responds to the hand control commands to position the chair in the sit, recline and stand positions.

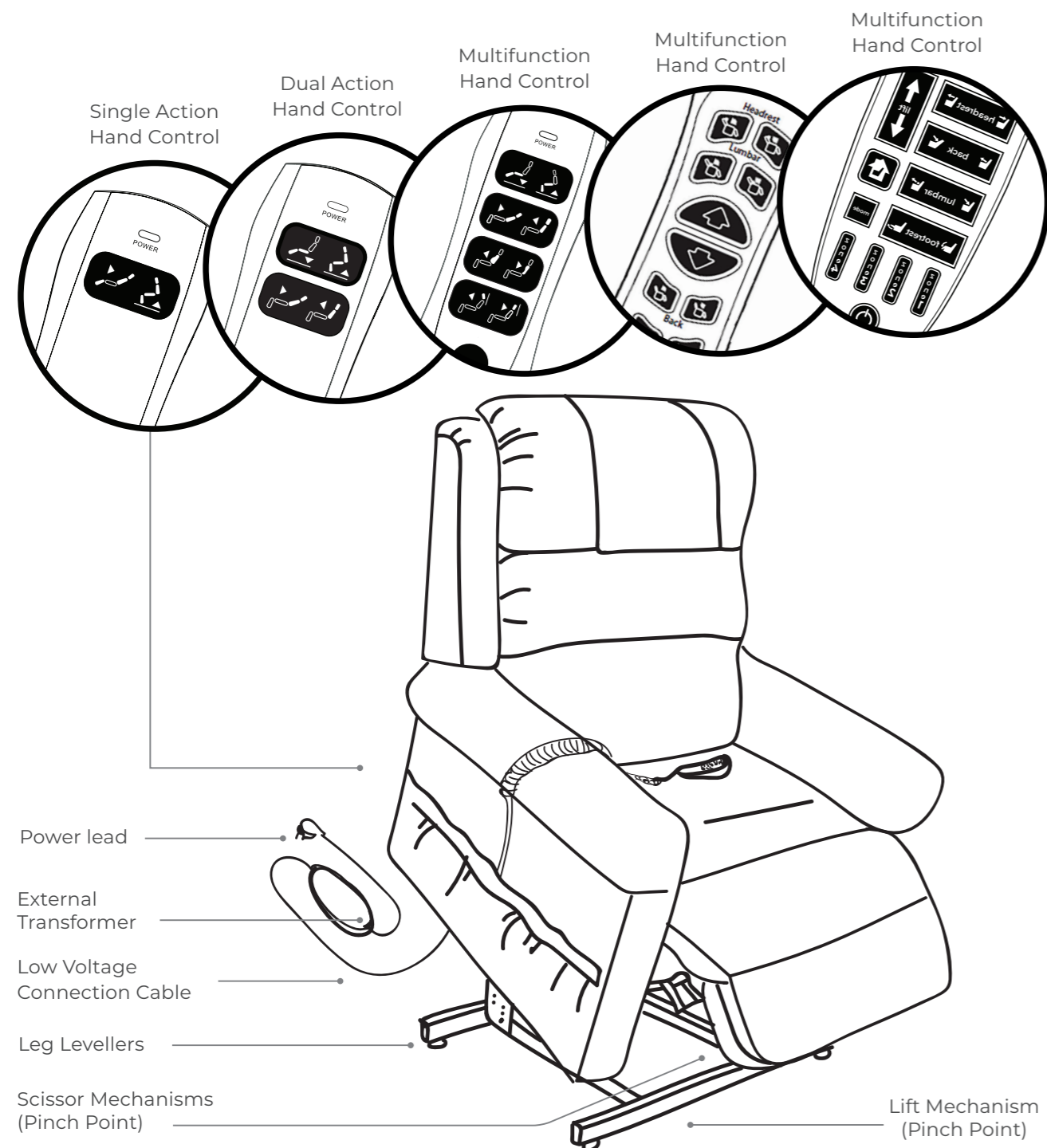

Figure 3.2 Scissor Mechanism

Scissor Mechanisms: Extend or retract to take the chair through the various stages of recline.



WARNING! Pinch/Crush Points Hazard! Be aware that the lift mechanism and scissor mechanisms are a pinch point on the lift chair. Keep the following items and similar objects clear of these points when operating the lift chair:

- Appendages
- Small children
- Pets
- Wires
- Oxygen tubes
- Loose items, including but not limited to clothing and blankets
- Electrical power leads

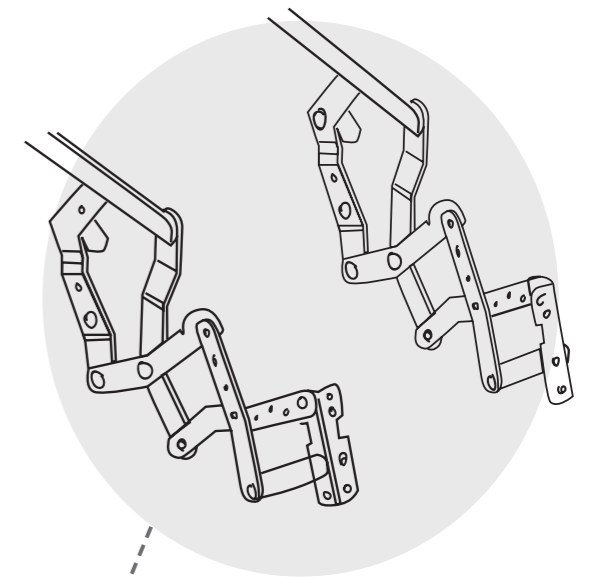

Scissor Mechanism (Pinch Point)

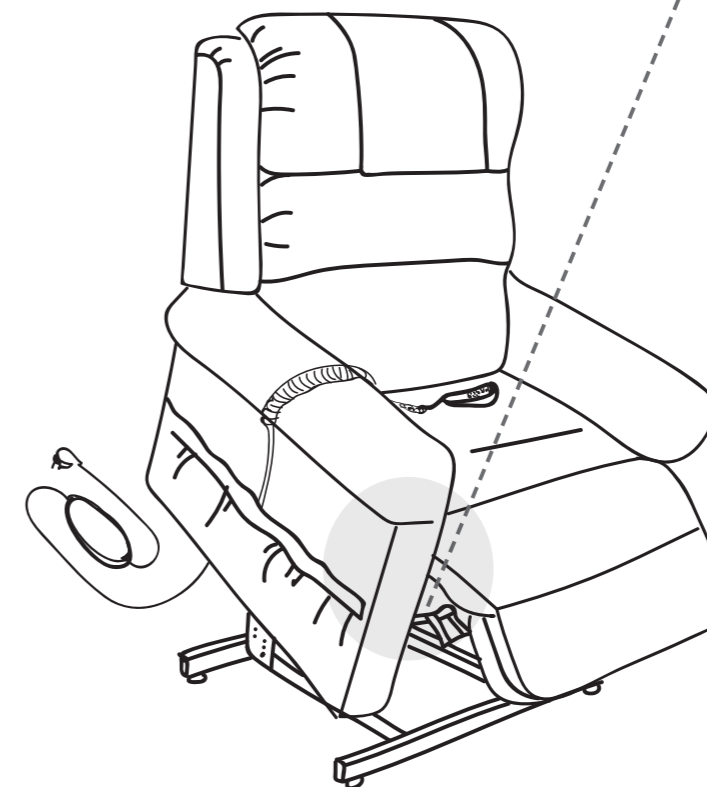

8. ASSEMBLY/DISASSEMBLY

ELECTRICAL COMPONENTS

Your Aspire Lift Chair is equipped with a low voltage DC motor system that reduces the standard household alternating current of 90V AC - 264V AC to direct current (24/39V DC). The electrical components include the external transformer, batteries and hand control. Keep these areas free from moisture at all times.



WARNING

WARNING! Keep all electrical components free from moisture at all times to prevent shock and/or electrical hazard.

External Transformer: Connects to a standard electrical outlet to provide power to the lift chair. The transformer may be equipped with an LED indicator, which shows green when power to the transformer is on.

The external transformer may also come equipped with mounting brackets that allow the transformer to be mounted to the wall directly under the standard electrical outlet. The screws must be mounted to the wall stud for security. Refer to "Appendix B" for a mounting diagram.

NOTE: Aidacare is not responsible for damage due to improper installation.

Batteries: Provide the power needed to return the lift chair to an upright or semi-upright position in the event of a power failure. Batteries are not included and must be installed into the external transformer. See IV. "Assembly/Disassembly."

NOTE: The batteries will provide power for only a short period of time after power is removed from the system, so it is important to act quickly in the event of a power failure. Engage and hold the up/down switch in the UP position as soon as possible. Maintain a steady pressure on the switch to avoid excessive draw from the battery and achieve the most amount of lift. Keep in mind that the amount of lift the batteries will be able to provide is affected by user weight and battery condition.

Hand Control: Contains the controls needed to operate the various functions of the lift chair. Refer to V. "Operation" for more information. The hand control may be equipped with a quick-release connector, which enables the user to detach the hand control from the lift chair, disabling all functions of the hand control.

Your lift chair may require some assembly before initial use. It may also require disassembly to make servicing the chair more convenient. If your lift chair is a Knock-Down (KD) model, follow the instructions in "Lift Chair Set-up." If your lift chair is not a KD model, proceed to "Lift Chair Placement."

LIFT CHAIR SET-UP

KD models will arrive in the knock-down position (Fig. 4.1).

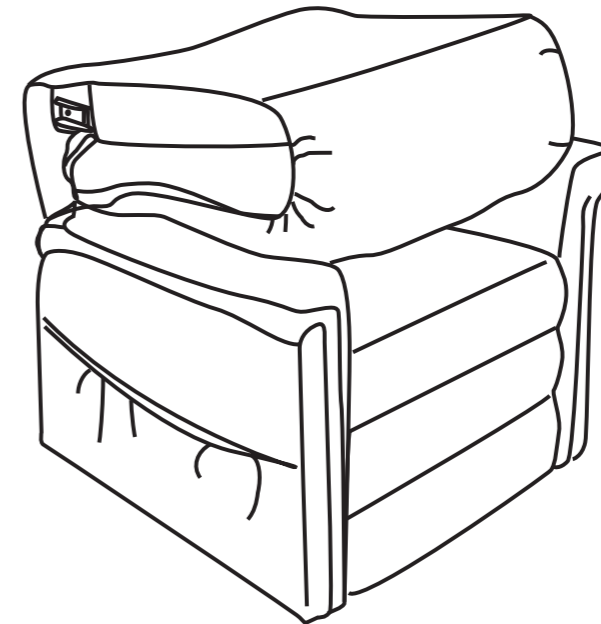
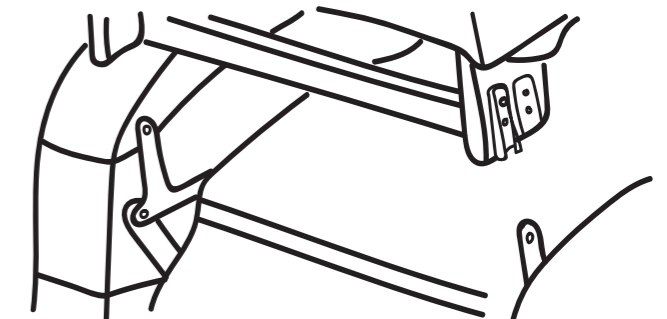
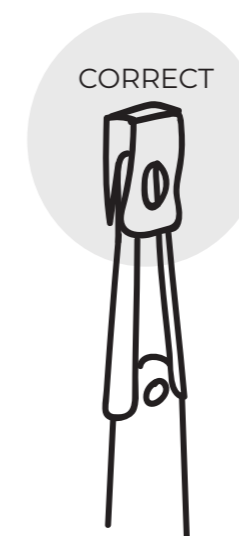

Figure 4.1 Knock-Down (KD) Position

Follow these steps to assemble the lift chair:



4.1.1 Remove the packaging from the back portion of the chair and check that the locking clip is in the vertical position. Reposition if necessary.



4.1.2 Slide the left and right KD sleeves of the chair back onto the KD connections on the arms and seat of the chair.

NOTE: Depending on chair width, you may need to slide on one side of the chair-back at a time. If this is the case, level the chair back before pressing down to lock into position.

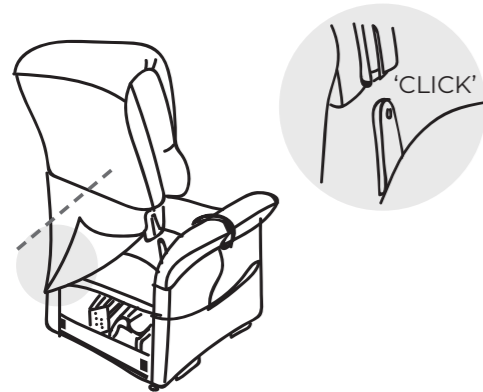

4.1.3 Push firmly on the top of the chair-back to lock into position. Listen for a click on each side to ensure the chair-back is locked in properly.

NOTE: Pull up on the chair-back to ensure that it is locked in place. If the back can be pulled off, then repeat steps 4.1.1 through 4.1.3.

LIFT CHAIR PLACEMENT

Your lift chair should be placed near a standard electrical outlet on dry, level ground where there is ample room to allow for proper operation. It is recommended that you have the assistance of an attendant when positioning the lift chair to avoid the possibility of injury when lifting.

Follow these steps to position the lift chair in a safe manner:

- The back of the lift chair should be positioned with sufficient clearance to avoid any obstructions, particularly behind the chair after reclining. Suggested clearances by model are:

SINGLE ACTION

Porto Zero Gravity - 350mm
Signature - 160mm
Oregon - 800mm

DUAL ACTION

Maui - 550mm
Idaho - 800mm
Signature - 480mm

QUATTRO ACTION

Montana - 580mm
Renoir - 510mm (Small)
Renoir - 570mm (Med, Large)
Raphael - 580mm (Med to Maxi)
Matisse Petite - 700mm
Gabriel Small - 500mm
Gabriel Large - 550mm

- Adjust the leg levelers to stabilise the lift chair (if provided)
- Install the batteries into the external transformer. Refer to “Battery Installation” for more information.
- Position the external transformer on the floor in an open, well-ventilated area where it will not be an obstruction.
- Position the low voltage connection cable (cable from transformer to chair), where it will not be pinched between the frame and the lift mechanism.
- Connect the low voltage connection cable to the external transformer if it is not already connected.
- Plug the power lead directly into the electrical outlet. Do not use an extension lead!

NOTE: If you discover a problem at any point during the set-up and positioning of your lift chair, stop and contact your authorised Aspire Dealer immediately. To avoid personal injury and/or product damage, do not plug the unit into the electrical outlet until the problem is corrected and do not attempt to fix electrical problems by yourself.

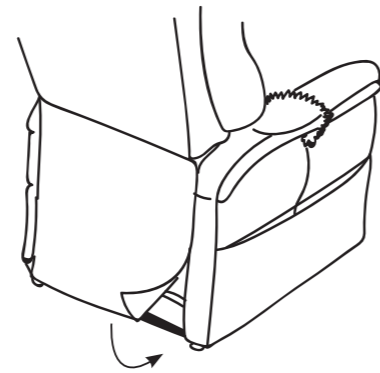

4.1.4 Attach the chair-back to the hook and loop flaps on the bottom of the chair base.

BATTERY INSTALLATION

Your lift chair may be equipped with a battery backup system that will activate during a power failure. The backup system is powered either by two 9V Lithium-Ion batteries (not included) that need to be installed into the external transformer OR by an external lithium ion battery pack (not included).

INSTALLING 2 X 9V BATTERIES

Follow these steps to install the batteries:

- Unplug the external transformer power lead from the electrical outlet (lead from transformer to wall).
- Open the marked battery door on the external transformer.
- Install two 9V lithium-ion batteries into the external transformer (Fig. 4.2.1).
- Replace the battery door.

NOTE: Always make sure the external transformer is equipped with two fresh 9V batteries. The battery backup system does not recharge itself. Fresh batteries are defined as 9V Lithium-Ion batteries that are replaced every time the battery backup system is activated during a power failure, or once a year if the battery backup system has not been activated.

NOTE: If you unplug your lift chair for an extended period of time (more than one hour), remove the batteries from the external transformer. The lift chair will draw power from the batteries even when it is not in use.

IDEA: Check 9V Lithium-Ion battery every year when you check your smoke alarm!

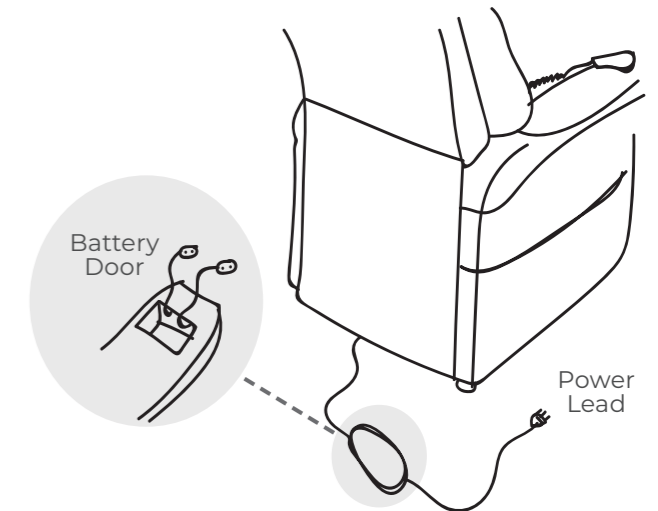

External Transformer (Top and Bottom View)

Figure 4.2.1 Lift Chair Battery Backup Location

INSTALLING EXTERNAL LITHIUM-ION BATTERY PACK

If your chair is equipped with an external transformer with a lithium-ion battery pack, your chair may be operated without being plugged into an electrical outlet for up to 48 hours.

Follow these steps to replace the lithium-ion battery pack batteries (See Figure 4.2.2 and Figure 4.2.3):

1. Unplug the external transformer power cord from the electrical outlet.
2. Position the external transformer so that the lithium-ion battery is facing upward.
3. Gently bump with your hand the end of the lithium-ion battery pack to dislodge it from the external transformer.
4. Slide the lithium-ion battery until it stops and then lift the lithium-ion battery off of the external transformer.
5. Place the new lithium-ion battery on top of the external transformer with the securement grooves toward the external transformer. (Figure 4.2.3)
6. Slide the new lithium-ion battery onto the external transformer until it clicks into place.

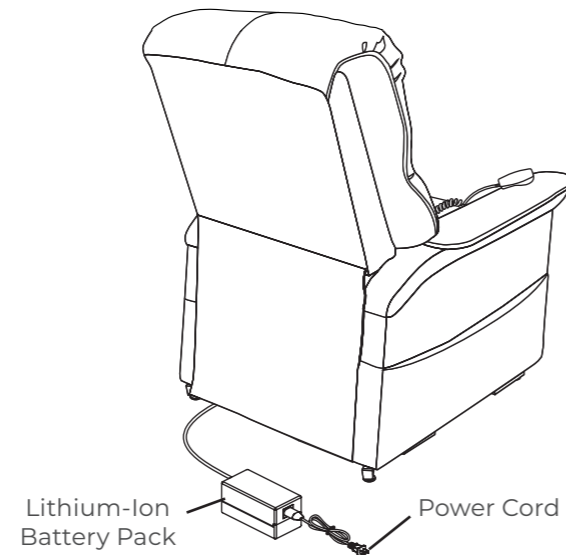

Figure 4.2.2 Lift Chair Battery Back Up Location

NOTE: Remove the lithium-ion battery from the battery pack when your chair isn't being used for an extended period of time. The chair will draw power from the battery even when it is not in use.

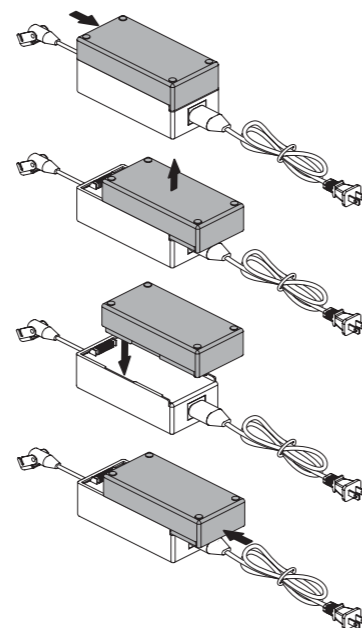

Figure 4.2.3 Lithium-ion Battery Replacement

HOW TO FIT CASTORS

If your chair is equipped with an external transformer with a lithium-ion battery pack, your chair may be operated without being plugged into an electrical outlet for up to 48 hours.



4.3.1 Flip chair onto side to access castor mounts



4.3.2 Attach castor stem through plare, lock in place with retaining nut



4.3.3 Stand chair up into neutral position

NOTE: Ensure rear castors are locked at all times when not moving the chair.

LIFT CHAIR DISASSEMBLY

The back rest of Aspire Lift Chairs can be removed to make service and transport of the chair more convenient.

Follow these steps to disassemble the lift chair:

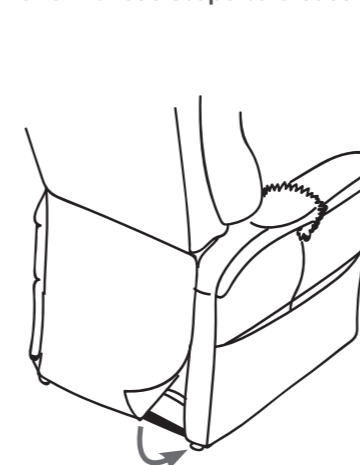

4.4.1 Remove the bottom of the back fabric from the hook and loop flaps on the chair base.

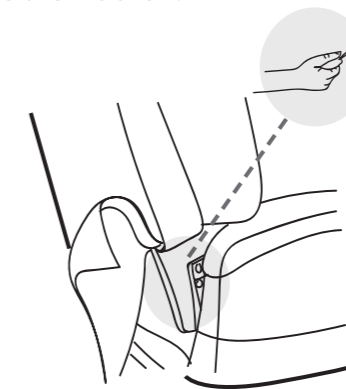

4.4.2 Using a large flat-head screwdriver, lift the left and right locking clips on the chair-back one side at a time to raise the back from the connections on the chair base. As you lift each locking clip, pull up on the chair-back to lift that side over the lock.

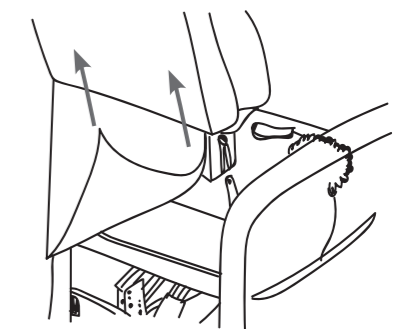

4.4.3 Lift the chair-back up and away from the chair base.

9. OPERATION

SAFE OPERATING PRECAUTIONS

There are certain precautions that should be taken during the operation of your lift chair. Read and follow these precautions carefully in order to ensure safe lift chair operation and to prevent injury and/or product damage.

- Plug the power lead directly into the electrical outlet. Do not use an extension lead!
- Do not place anything (e.g. a drinking glass) on top of or near the external transformer
- If the external transformer box or hand control requires cleaning, unplug the power lead from the electrical outlet and use a clean, dry cloth or lightly dampened cloth. Dry completely before plugging the power lead back into the electrical outlet
- Periodically check the hand control and all power leads for visible damage
- Keep the hand control away from all heated surfaces
- Ensure the hand control is out of the way before sitting in the chair
- Keep children and pets away from all moving parts while operating the lift chair
- Do not allow children to play on or operate the lift chair. Only the intended user should operate the lift chair
- Avoid pinch points, such as the lift and scissor mechanisms. Keep hands and feet clear of these areas
- Always leave the lift chair in an upright and closed position when not in use
- Do not sit or stand on the footrest
- Do not “drop” into the lift chair when sitting if it is in a partially raised position, this will damage the seating and void warranty



PROHIBITED! Do not place objects under the lift chair make sure area is clear of obstructions, including pets and small children during operation.

WARNING! Prevent potential equipment damage! Do not place the external transformer under the lift chair.



WARNING

WARNING! Do not cover the external transformer. Keep the transformer in an open well-ventilated area free from foreign material/debris to ensure proper operation.

HAND CONTROL OPERATION

Depending on lift chair model, the hand control may be equipped with switches that control the movement of the chair-back, chair base and footrest (**Fig. 5.1, 5.2 and 5.3**).



WARNING

WARNING! Do not lean on or apply downward force to the chair-back when the lift chair is in fully reclined position. Doing so could cause the lift chair to tip, resulting in personal injury and/or product damage.

WARNING! Do not use the footrest as a seat, or for purposes outside its intended use. Doing so could cause instability in the lift chair and place undue stress on lift chair components, resulting in personal injury and/or product damage.

WARNING! Be sure to lock or disconnect the hand control when the lift chair is not in use

HAND CONTROL OPERATION

SINGLE ACTION - CHAIR MODEL



PRESS & HOLD to initiate symbol
RELEASE button to stop

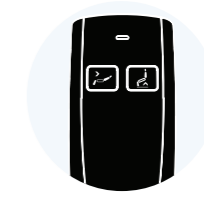

Hand Control for Oregon Lift Recliner

All functions are the same however handset is different in appearance.

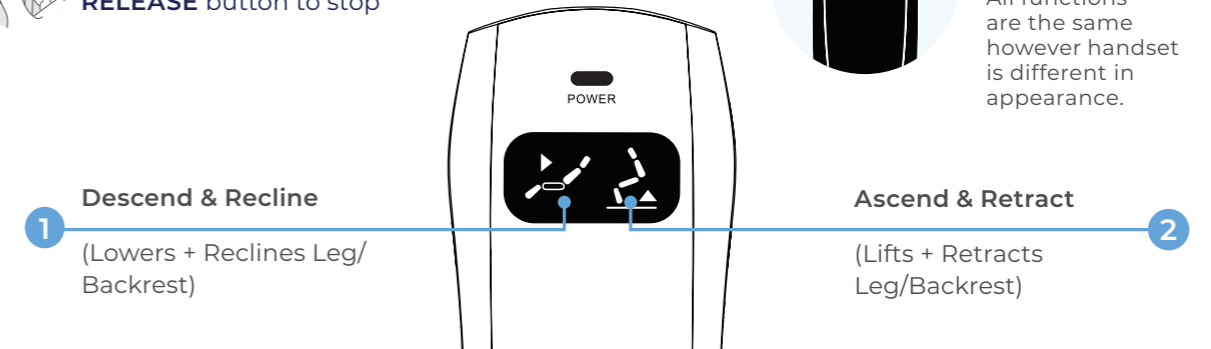

1. Descend & Recline

Descend (Stand-to-sit): If situated in lift position, the chair will lower before transitioning into a recline position.

Recline: Simultaneously lowers the backrest and extends legrest to maximise comfort and relaxation.

2. Ascend & Retract

Ascend (Lift-to-stand): Raises and tilts the chair forwards to assist users with standing.

Retract: Resets the chair to its original upright position, by simultaneously retracting the backrest and legrest.

DUAL ACTION - CHAIR MODEL



PRESS & HOLD to initiate symbol
RELEASE button to stop



Hand Control for Oregon Lift Recliner

All functions are the same however handset is different in appearance.

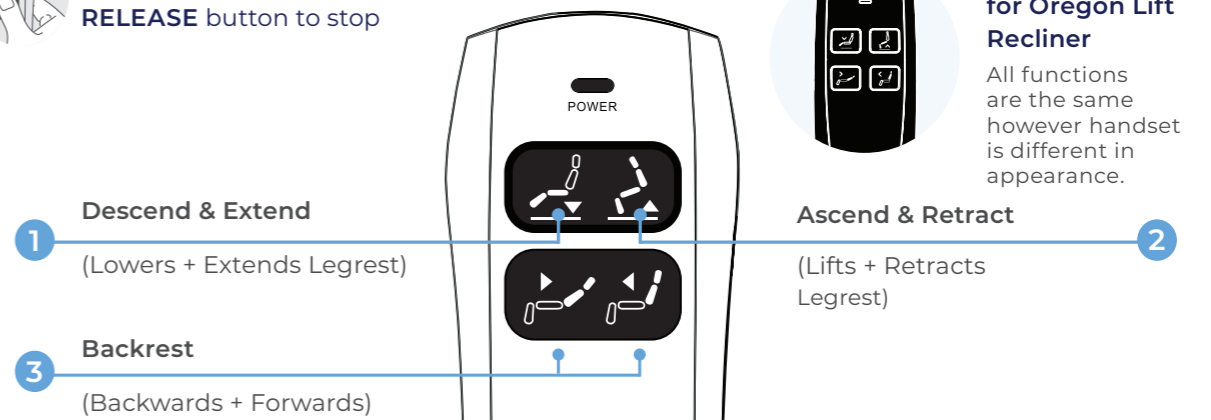

1. Descend & Recline

Descend (Stand-to-Sit): If situated in lift position, the chair will lower before extending the legrest

2. Ascend & Retract

Ascend (Lift-to-Stand): Raises and tilts the chair forwards to assist users with standing.

Retract: Retracts legrest to achieve a comfortable seated position.

3. Backrest

Adjusts the backrest to provide postural support whatever the activity.

MULTI-ACTION - CHAIR MODEL

 **PRESS & HOLD** to initiate symbol
RELEASE button to stop

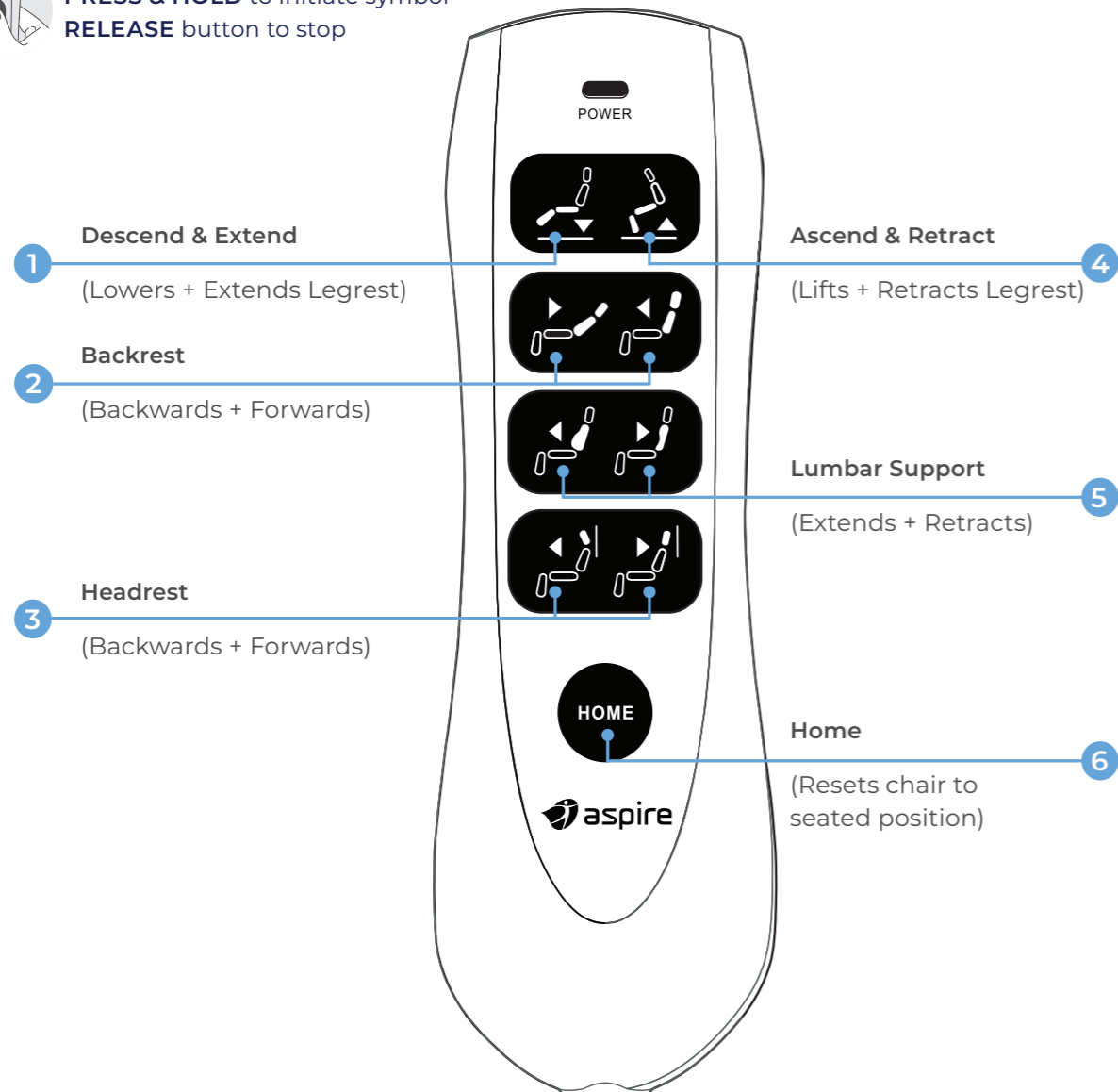

1. Descend & Extend

Descend (Stand-to-Sit): If situated in lift position, the chair will lower before extending the legrest.
Extend: Extends legrest to maximise comfort and relaxation.

2. Backrest

Adjusts the backrest to provide postural support whatever the activity.

3. Headrest

Adjusts the headrest to help alleviate neck muscle strain, providing optimal support while reading or watching TV.

4. Ascend & Retract

Ascend (Lift-to-Stand): Raises and tilts the chair forwards to assist users with standing.
Retract: Retracts legrest to achieve a comfortable seated position.

5. Lumbar Support

Adjusts the inbuilt lumbar cushion to provide tailored lower back support.

6. Home

Resets the chair to the seated position.

MULTI-ACTION - CHAIR MODEL

 **PRESS & HOLD** to initiate symbol
RELEASE button to stop

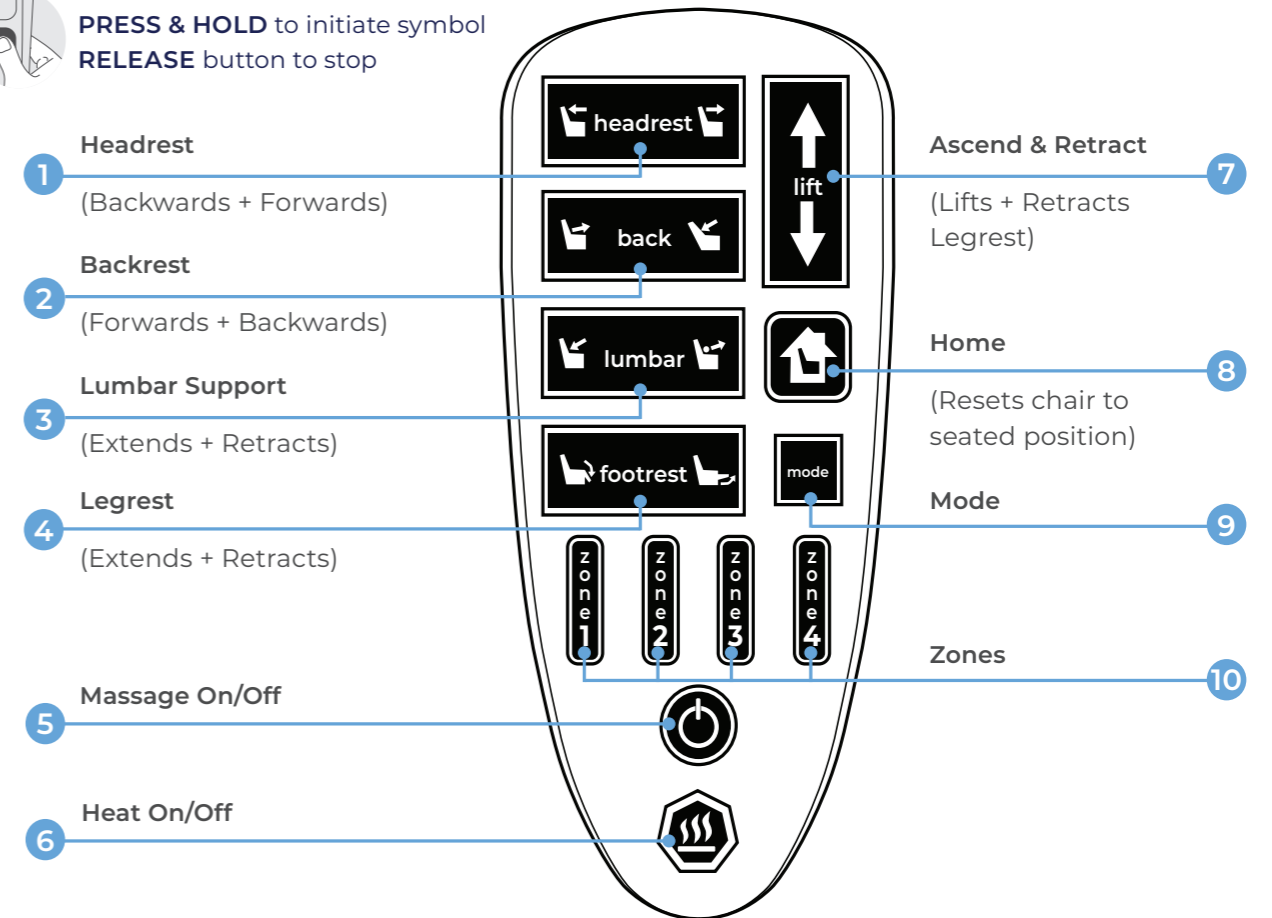

1. Headrest - Adjusts the headrest to help alleviate neck muscle strain, providing optimal support while reading or watching TV.

2. Backrest - Adjusts the backrest to provide postural support whatever the activity.

3. Lumbar Support - Adjusts the inbuilt lumbar cushion to provide tailored lower back support.

4. Legrest - Adjusts the legrest to provide postural support whatever the activity.

5. Message On/Off - Turns air massage zones and modes on and off when pressed. If on, heat will turn off when the air massage is turned off. It will not turn on if the power button is pressed again.

6. Heat On/Off

7. Ascend & Retract - Ascend (Lift-to-Stand): Raises and tilts the chair

8. Home - Resets the chair to the seated position. If you continue holding the button, the chair will ascend to assist users with standing.

Retract: Retracts the legrest to achieve a comfortable seated position.

9. Mode - Push this button to change the air massage mode. Push again to cycle through the modes. The LEDs signify which mode is selected:

- Red: Alternating Zones

- Green: Pulse

- Blue: Wave

- White: Massage is off

10. Zones - Customise your massage by choosing which zones are activated. Activated zones will be lit brighter than deactivated zones. If all zones are deselected, the massage will turn off.

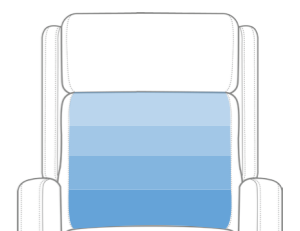

Zone locations

MULTI-ACTION - CHAIR MODEL

 **PRESS & HOLD** to initiate symbol
RELEASE button to stop

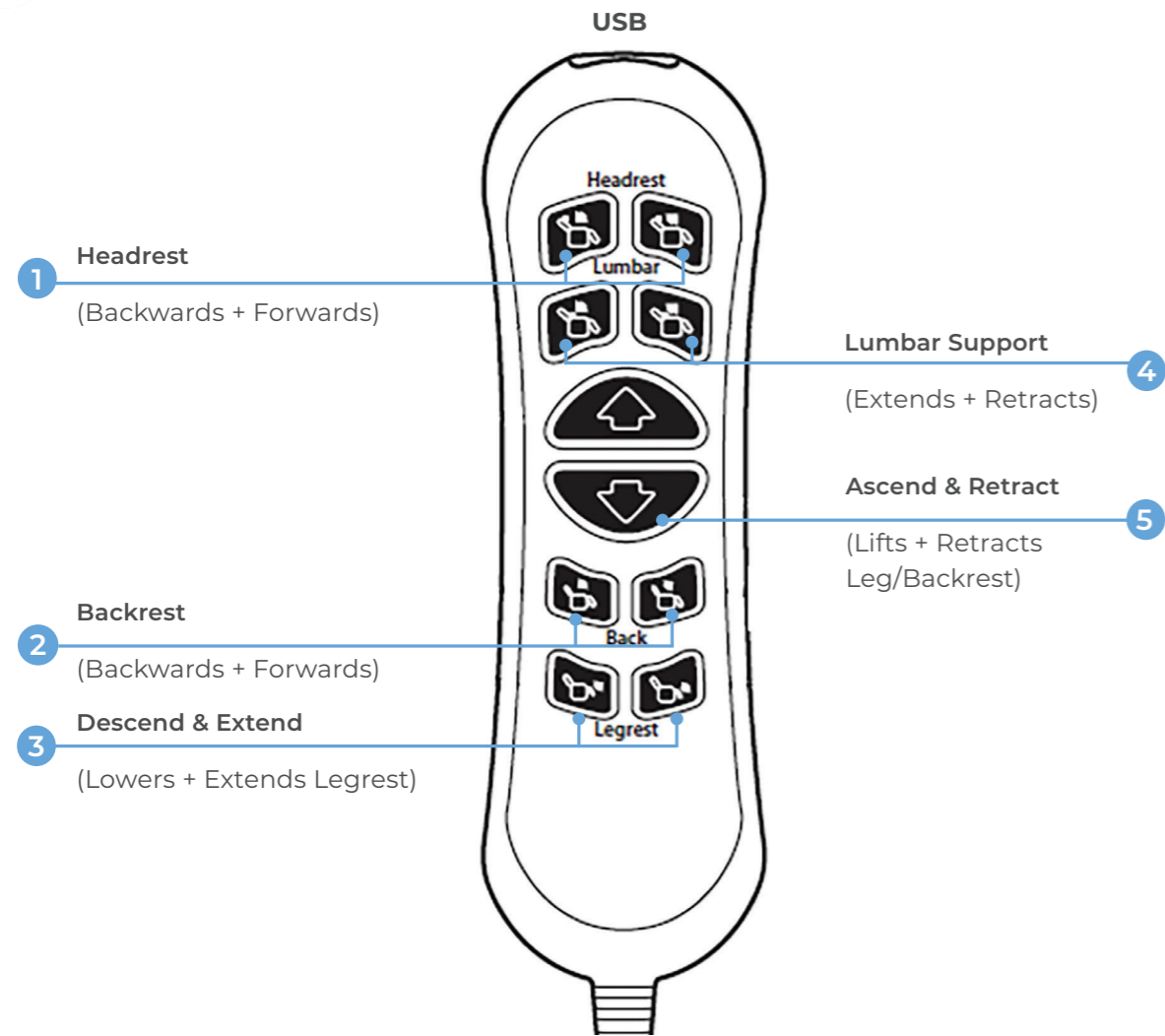

- 1. Headrest**
Adjusts the headrest to help alleviate neck muscle strain, providing optimal support while reading or watching TV.
- 2. Backrest**
Adjusts the backrest to provide postural support whatever the activity.
- 3. Descend & Extend**
Descend (Stand-to-Sit): If situated in lift position, the chair will lower before extending the legrest.
Extend: Extends legrest to maximise comfort and relaxation.
- 4. Lumbar Support**
Adjusts the inbuilt lumbar cushion to provide tailored lower back support.
- 5. Ascend & Retract**
Ascend (Lift-to-Stand): Raises and tilts the chair forwards to assist users with standing.
Retract: Retracts legrest and backrest to achieve a comfortable seated position.

CORRECT AND INCORRECT USE GUIDE

DOS AND DO NOTS

DOS

SITTING

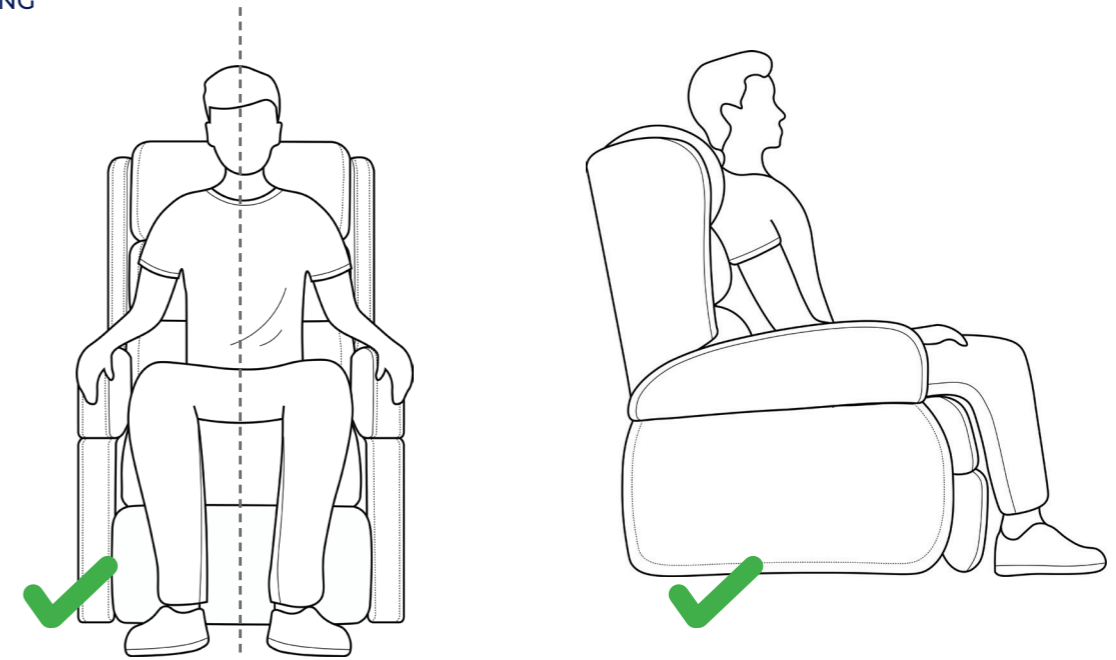

DO sit upright and centrally aligned in the chair.

LAYING

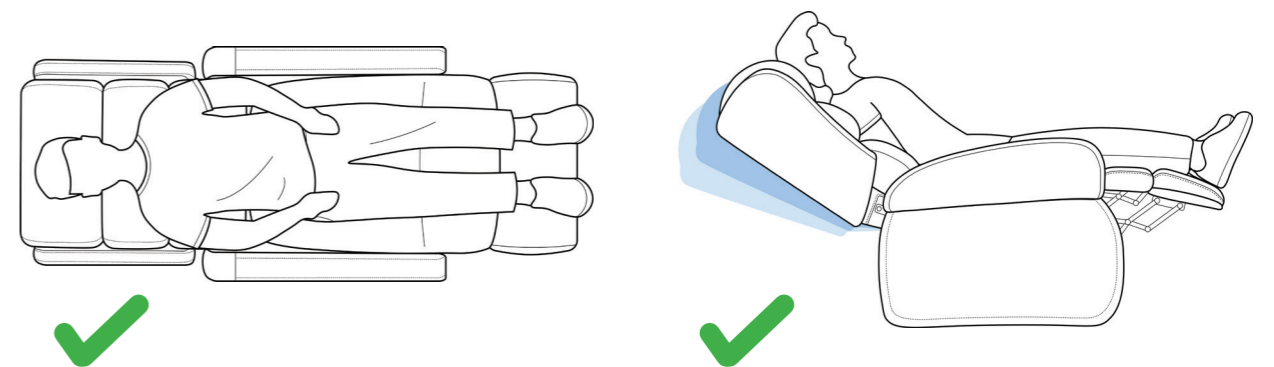

DO lie centrally and flat on the users back.



Chairs shown are for illustrative purposes only and may not be reflective of the specific chair model purchased.

DO NOTS



Misuse may injure the user, cause pressure and/or skin tear related issues, as well as damage the product.

SITTING



DO NOT sit skewed to one side of the chair.

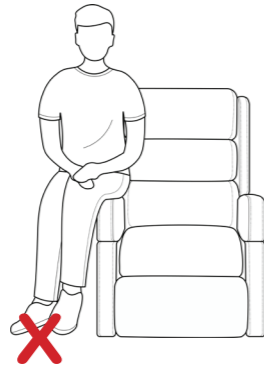

DO NOT sit on the armrest.



DO NOT distribute excess weight on the backrest.



DO NOT distribute excess weight on the armrest.

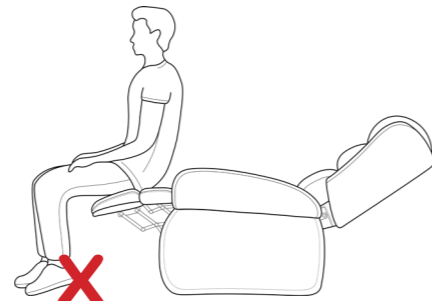

DO NOT sit on the footrest when extended.

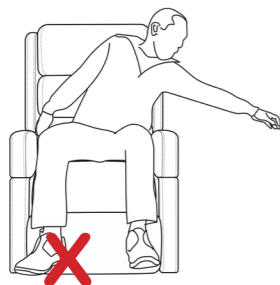

DO NOT reach to the side.

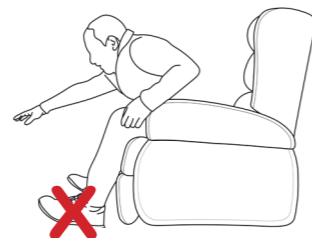

DO NOT lean forward.

LAYING

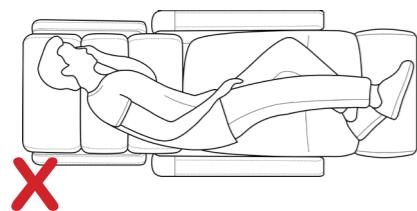

DO NOT lie on the side.

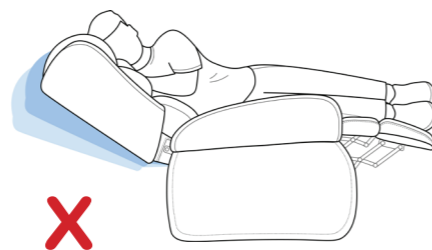

DO NOT reposition whilst on side.

10. TROUBLESHOOTING

Your Aspire Lift Chair is a state-of-the-art product designed to enhance your mobility. Your lift chair should bring you years of trouble-free service, however, it may require occasional troubleshooting. The following troubleshooting tips and FAQs should summarise what you need to know about your lift chair. If at any time you do not feel comfortable performing the troubleshooting steps listed in this manual, contact your authorised Aspire Dealer for service. Please have the model number, serial number and nature of the problem when calling.

FREQUENTLY ASKED QUESTIONS (FAQS)

What if my lift chair does not operate at all?

- Ensure the external transformer is plugged into a properly wired electrical outlet.
- Check the circuit breaker box connected to the electrical outlet to ensure the outlet is receiving power.
- Ensure the low voltage connection cable is plugged into the external transformer.
- Ensure that all cables are connected properly.
- Check all cables for signs of damage (cuts, flattened areas).

What if my lift chair operates in one direction only?

- Check the up and down buttons or toggle switch on the hand control to make sure they do not stick. If the buttons or switch are sticking in either position, the hand control may need to be replaced.
- Contact your authorised Aspire Dealer for further assistance.

What if my lift chair stops during a lifting cycle?

- Your lift chair is equipped with an internal thermal shutoff switch located inside the external transformer that prevents the motor control box from overheating. If the thermal shutoff activates, allow the lift chair to remain in a stationary position for 10 minutes to allow the motor to cool, then resume normal operation. If you notice the motors overheating frequently, contact your authorised Aspire Dealer.
- There may have been a power failure and/or there are no batteries in the external transformer or the batteries have no charge. Always make sure there are fresh 9V Lithium-Ion batteries in the external transformer if equipped with battery backup.
- Check the circuit breaker box connected to the electrical outlet.

What if my lift chair is rocking from corner to corner after I position the chair?

The floor may be uneven or the carpet may be affecting chair position. Adjust the leg levellers in the area where the chair is rocking. See III. "Your Lift Chair" for instructions on levelling your chair.

Where can I place the external transformer box?

On the floor away from heat sources in an open, well-ventilated area where it will not be an obstruction.

Where do I find the serial number on my lift chair?

You can find the serial number in two locations—one is near the rear of the motor on the steel lift mechanism, and the second is attached to the frame below the scissor mechanisms. The model number for your lift chair is printed below the serial number bar code.

Who do I call for service?

Contact your authorised Aspire Dealer for service.

11. CARE AND MAINTENANCE

Your Aspire Lift Chair will require routine maintenance checks. You can perform some of these checks, but others may require assistance from an authorised Aspire Dealer. By following the maintenance checks in this section as scheduled, you can help ensure your lift chair gives you years of trouble-free operation. If you have any questions regarding your lift chair's care, contact your authorised Aspire Dealer.

FABRIC AND UPHOLSTERY CARE

- Inspect the fabric on a regular basis for any pulls, tears or gaps.
- Fabric care instructions can be found on the tag under the headrest cushion.

Different Upholstery and Recliner Models:

• Standard Fabric (Oregon and Idaho):

We recommend Dry Cleaning. However, you can gently spot clean the blemish with water using a clean and non-abrasive microfibre cloth, only if absolutely necessary.

• Quilted Fabric (Maui and Verona):

We recommend Dry Cleaning. However, you can gently spot clean the blemish with water using a clean and non-abrasive microfibre cloth, only if absolutely necessary.

• Microsuede (Raphael - Standard, Signature & Matisse):

This type of Microsuede has a waterproof coating applied*. We recommend Dry Cleaning. However, you can gently spot clean the blemish with water using a clean and non-abrasive microfibre cloth, only if absolutely necessary. Excessive spot cleaning will remove the waterproof coating.

*Please note that this fabric is not to be confused or substituted with a crypton-like fabric and/or fabrics with polyurethane backings. This product is not suitable for people with incontinence issues or concerns.

• Nordic Stone Vinyl (Raphael - Standard), Latte Vinyl (Oregon & Idaho) & Heritage Vinyl (Signature):

Spot clean with water using a clean and non-abrasive microfibre cloth.

DO NOT USE: Soap, chemicals and/or other solutions used to clean the stain or spot, may damage and/or affect the performance characteristics of the vinyl.

• Warwick Custom Upholstery (Raphael – Custom):

Fabric care instructions can be found at the rear of the chair (see Fig. 7.1). These instructions are specific to your Raphael with customised upholstery for the following ranges:

- Warwick La Casa (Leather)
- Warwick Lustrell Ranger (Healthcare Vinyl)
- Warwick Eastwood (Microsuede)
- Warwick Mazza Mania (Soft Touch Fabric)

(Refer to the "Warranty" section for more information).

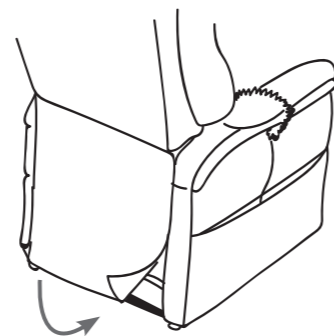

Fig. 7.1: Fabric Care instructions label.

FABRIC AND UPHOLSTERY CARE CONTINUED...



WARNING! Fabric should not be allowed to come in direct contact with any type of heat source (e.g. a space heater or cigarette). Personal injury or fire damage may occur.

WARNING! It is strongly recommended that you do not smoke cigarettes while seated in or using your lift chair, although the lift chair has passed the necessary testing requirements for cigarette smoking. You must adhere to the following safety guidelines if you decide to smoke cigarettes while seated in or using your lift chair.

- Do not leave lit cigarettes unattended.
- Keep ashtrays a safe distance from the lift chair.
- Always make sure cigarettes are completely extinguished before disposal.

PLEASE NOTE:

- Do not use solvent-type cleaners to spot clean.
- Do not saturate the fabric.
- Prevent damage to the fabric; do not expose the lift chair to direct sunlight.

ELECTRONICS CARE

- Inspect all wiring harnesses to make sure they are not damaged or frayed.
- If damage is present, unplug the lift chair and contact your authorised Aspire Dealer for service.
- Keep all electronics free from moisture and temperature extremes.
- Aspire Lift Chairs are intended for indoor use only!



WARNING! Even though the lift chair has passed the necessary testing requirements for ingress of liquids, you should keep electrical connections away from sources of dampness, including direct exposure to water or bodily fluids and incontinence. Check electrical components frequently for signs of corrosion and replace as necessary.

WARNING! Plastic bags are a suffocation hazard. Dispose of plastic bags properly and do not allow children to play with them.

12. WARRANTY

TWO-YEAR LIMITED WARRANTY

For two (2) years from the date of purchase, Aidacare will repair or replace at our option to the original purchaser any of the following parts found upon examination by an authorised representative of Aidacare to be defective in material and/or workmanship:

- Steel Frame
- Motor
- Hand Control
- Scissor Mechanisms
- Steel Lift Mechanism

IMPORTANT INFORMATION!

Improper and/or incorrect usage of the product will void product warranty. Please familiarise and refer to the “Correct and Incorrect Use Guide” located in the “Operation” section of the user manual for more details.

NOTE: Aidacare reserves the right to replace only the part of the steel lift mechanism that may be defective. Aidacare provides parts only under warranty. Your Aspire Dealer is responsible for labour and service. Please contact your Aspire Dealer for information about these services and for any applicable charges.

TWO-YEAR FABRIC WARRANTY

“Fabric and Upholstery Care” instructions specific to your Aspire Recliner are located in the “Care and Maintenance” section of this user manual. Failure to follow, protect and/or care for the upholstery/textile in the intended way (refer to “Care and Maintenance” section) will void product warranty.

Aidacare guarantees to replace any fabric that is found to be faulty as a result of manufacturing defect and which has been used in accordance with our manufacturer performance ratings and care instructions.

An evaluation of fabric related issues must be conducted before confirmation of warranty coverage can be verified

Consumer Warranty Against Defects:

Aidacare is bound by Australian Consumer Law in respect to Warranty Against Defects. A copy of the Aidacare Warranty Against Defects statement is available on the Aidacare home page at aidacare.com.au. All warranty matters should be directed to Aidacare Customer Service on 1300 133 120.

Aidacare does not warrant against excessive or innocent use, modification or any situation that could not be deemed as fair wear and tear. This is a back to base warranty and does not cover freight costs pertaining to the return of any items under warranty. Aidacare acknowledges and conforms to all ACCC guidelines around consumer rights. For further information contact Aidacare on; 1300 133 120 or email product@aidacare.com.au

Aidacare will not warrant the safety and or correct functioning of products where any original components have been changed or modified by non-Aidacare approved and trained service and maintenance staff or external providers. Furthermore, safety is not guaranteed where components have been replaced with non-original Aidacare approved parts. If any faults are detected upon receipt of this product please phone Aidacare. Any faults that are detected during normal use should be reported to Aidacare immediately to determine if warranty conditions apply and if so, the necessary repair or replacement work to be completed.

Spare parts list is available upon request.

13. SPECIFICATIONS

ASPIRE RECLINER

MODELS:

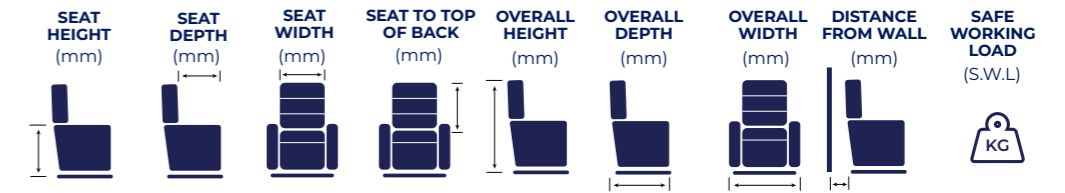

Model	SEAT HEIGHT (mm)	SEAT DEPTH (mm)	SEAT WIDTH (mm)	SEAT TO TOP OF BACK (mm)	OVERALL HEIGHT (mm)	OVERALL DEPTH (mm)	OVERALL WIDTH (mm)	DISTANCE FROM WALL (mm)	SAFE WORKING LOAD (S.W.L.) (KG)
Raphael (Small)	470	480	480	630	1100	880	740	560	130kg
Raphael (Medium)	470	500	520	680	1150	880	810	580	130kg
Raphael (Large)	500	530	550	700	1200	880	810	580	130kg
Raphael (Maxi)	510	540	650	650	1160	880	930	580	180kg
Renoir (Small)	450	510	510	660	1010	740	750	510	130kg
Renoir (Medium)	470	530	560	700	1060	740	800	570	130kg
Renoir (Large)	470	530	580	700	1060	740	830	570	130kg
Porto Zero Gravity	490	500	490	690	1180	840	770	350	150kg
Maui	500	500	540	630	1130	820	780	550	130kg
Montana	510	540	650	650	1160	880	930	580	220kg
Montana HD	500	530	650	650	1220	950	1000	600	254kg
Montana HD450	500	530	800	650	1220	950	1150	600	450kg
Oregon	480	480	480	750	1100	950	800	800	150kg
Idaho	480	480	480	750	1100	950	800	800	150kg
Signature Space Saver (Small)	480	460-485	480	580	980	690	740	160	145kg
Signature Space Saver (Medium)	480	490-515	510	620	1050	715	780	160	145kg
Signature Space Saver (Large)	500	510-535	540	650	1100	740	780	160	145kg
Signature Dual Action (Small)	480	460-485	480	580	980	710	740	480	155kg
Signature Dual Action (Medium)	480	490-515	510	620	1050	735	780	480	155kg
Signature Dual Action (Large)	500	510-535	540	650	1100	760	780	480	155kg
Matisse (Petite)	457	457	508	559	1016	965	914	700	136kg
Matisse (Large)	500	545	570	730	1065	1065	965	580	159kg
Gabriel (Small)	475	450	490	710	1100	880	850	500	150kg
Gabriel (Large)	500	520	530	780	1170	930	900	550	155kg

14. APPENDIX A

ASPIRE LIFT RECLINER WEIGHT CAPACITY	
Model	Rated Weight Capacity
Maui	130kg
Porto Zero Gravity	150kg
Raphael (Small, Medium and Large)	130kg
Raphael (Maxi)	180kg
Montana	220kg
Montana HD	254kg - 450kg
Oregon/Idaho	150kg
Signature Space Saver	145kg
Signature Dual Action	155kg
Matisse (Petite)	136kg
Matisse (Large)	159kg
Renoir	130kg
Gabriel Small	150kg
Gabriel Large	155kg



MANDATORY! Stay within the specified weight capacity of your lift chair. Exceeding the weight capacity voids Aspire Lift Chair warranty.

15. NOTES

AIDACARE PTY LTD

Building 3A, 1 Moorebank Avenue,
Moorebank NSW 2170
Australia

1300 133 120 | aidacare.com.au

AIDACARE LIMITED

Arcadia House, Maritime Walk,
Ocean Village, Southampton SO14 3TL
United Kingdom

01622 541235 | aidacare.co.uk

MADE IN PRC

ASUM39.71 250724

