



# A200S ALUMINIUM STANDING LIFTER

USER MANUAL



Congratulations and thank you for choosing an Aidacare Aspire A200S Standing Lifter.

This product has been designed to offer maximum safety for the user and reduced manual handling for the carer. Aidacare Aspire standing lifters are for indoor use only.



**Important:** Do not use the Aidacare Aspire A200S Standing Lifter without having first read this manual.



This product Features the UKCA mark, in compliance with Part II UK MDR 2002 (as amended) Class 1.

© Aidacare Limited 2023

No part of this user manual may be copied, distributed, reproduced, scanned or stored on any electronic database, whether in whole or in part in any form or by any means.

Due care has been taken to ensure all the information contained in this user manual is correct at the time of printing. All measurements, pictures, colours and weight capacities are to be used as a guide only. We reserve the right to modify the design or appearance of any product displayed in this user manual without prior notice.

## TABLE OF CONTENTS

---

1. Symbols Used In This Manual	4
2. Symbols Used On The Product	5
3. Overview	5
4. Safety Precautions & Warnings	6
5. Intended Use	6
6. Parts Glossary	8
7. Assembly	9
8. Preliminary Checks	11
9. Standing Lifter Operation	11
10. Standing Guide	15
11. Sling Compatibility	16
12. Care & Maintenance	17
13. Compliance	18
14. Warranty & Service	18
15. Troubleshooting	19
16. Product Specifications	21
17. Recycling Instruction	22
18. Manufacturer, UK Representative & Importer Details	23

## 1. SYMBOLS USED IN THIS MANUAL

The symbols below are used throughout this user manual and on the product to identify warnings and important information. It is very important for you to read them and understand them completely.



**WARNING**

**WARNING!** Indicates a potentially hazardous condition/situation. Failure to follow designated procedures can cause either personal injury, component damage or malfunction. On the product, this icon is represented as a black symbol on a white triangle with a black border.



**ALWAYS!** These actions should be performed as specified. Failure to perform mandatory actions can cause personal injury and/or equipment damage. On the product, this icon is represented as a white infinity symbol on a black dot with a white border.



**DO NOT!** These actions are prohibited. These actions should not be performed at any time or in any circumstances. Performing a prohibited action can cause personal injury and/or equipment damage. On the product, this icon is represented as a white symbol with a black circle and black slash.

## 2. SYMBOLS USED ON THE PRODUCT



**Please note:** Sticker is sample only and not to scale

	Product Code		UKCA Mark
	Serial Number		Safe Working Load
	Manufacturer		Read User Manual
	Importer		Caution
	Country of Manufacture		Medical Device
	Class 2 Electrical Equipment		Authorized Representative in UK
	Type B as per IEC60601-1		Includes Electronics components and should not be mixed with General household waste

## 3. OVERVIEW

The **Aidacare Aspire A200S Standing Lifter** is a compact and ergonomically designed mobile standing lifter with a generous safe working load (SWL) of 200kg / 31.5st.

This mobile standing lifter offers a robust solution for in home care, institutional and aged care environments.









The A200S Standing Lifter allows patients to be transferred from sitting to standing with comfort and safety.

The compact T-shape yoke offers versatility in patient grip points and multiple sling hooks to meet various user and carer needs. The height and width adjustable knee pads offer lower leg comfort and security during transfers.

The Aidacare Aspire range of patient handling solutions feature industry leading LINAK Jumbo Care electronics and have been designed and tested to comply with ISO 10535:2006.

## 4. SAFETY PRECAUTIONS & WARNINGS

### SAFETY CONSIDERATIONS

-  **ALWAYS** ensure that attendants have read this guide before operating this lifter.
-  **ALWAYS** use slings that are assessed and considered suitable by a trained healthcare professional.
-  **ALWAYS** ensure the area around the lifter and patient is clear of obstructions.
-  **ALWAYS** minimise the distance over which the patient is being transferred by positioning support surfaces as close as possible.
-  **DO NOT** operate the lifter without training in the safe operation of lifters and slings. **IF IN DOUBT DO NOT USE.**
-  **DO NOT** use the lifter where any doubt exists regarding the safety of the lifter including but not limited to wear or damage with particular importance to be placed on the yoke and lifter sling attachment points.
-  **DO NOT** use the lifter with slings showing any signs of wear or damage, including fraying.
-  **DO NOT** exceed the 200kg / 31.5st safe working load of the Aidacare Aspire A200S Standing Lifter.
-  **DO NOT** use the lifter as a means of transportation over distances in excess of 3 metres. It is not designed as a transportation device.

## 5. INTENDED USE

The Aidacare Aspire A200S Standing Lifter has been designed to stand and transfer human patients with the assistance of one carer or attendant.

This product is suitable for indoor areas only and It should **NEVER** be used outdoors.

All Aidacare Aspire standing lifters should **ONLY** be used with Aidacare approved patient slings, which have been chosen and assessed by a competent trained health professional. For a complete list of all compliant lifting slings please contact Aidacare.



**IMPORTANT** – only approved slings and accessories are compatible with this lifter. If you are unsure please contact Aidacare.

The correct and appropriate use of the A200S Standing Lifter reduces the risks associated with manual patient handling. The transferring of patients should always be assessed and planned by a trained health professional.



This is the direction of travel for which this standing lifter has been designed.



**WARNING: DO NOT manually lift the boom of lifters.**

### How to Use Correctly:

The boom of the lifter is designed to be lifted only by an electric actuator.

Aidacare Lifters and Standing Lifters do not pull downwards during lowering. This safety spline feature is designed to avoid entrapment and crush injuries.

This safety feature means that it is physically possible to raise the lifter boom by hand on some models with LA31 actuators fitted.



**DO NOT** raise the lifter boom by hand or any other means except under direct drive from the electric actuator fitted to the lifter.

Raising the boom can cause it to become stuck in an elevated position. Under load this can result in the patient to free fall and risks catastrophic injury to the patient and/or carer.



**ALWAYS** use the handset or control unit buttons to raise and lower the boom of the lifter. This will ensure correct and safe functioning at all times.



## 6. PARTS GLOSSARY



1	Boom	11	Adjustable Knee Pads
2	Sling Bar / Yoke	12	Rear Braking Castors
3	Lift Actuator	13	Foot Platform
4	Mast	14	Front Castors
5	Control Unit	15	Base Fastening Lever
6	Cover for Leg Actuator	16	Emergency Lowering
7	Leg Spread Actuator	17	Grip Handles
8	Emergency Stop		
9	Handset		
10	Push Handle		

## 7. ASSEMBLY



### 1. Unpack

Remove all parts from carton.

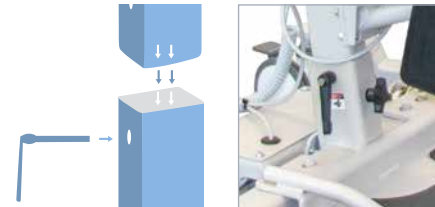

### 2. Attach the mast

Insert the mast into the base, ensuring the holes align and secure with base fastening lever bolt.

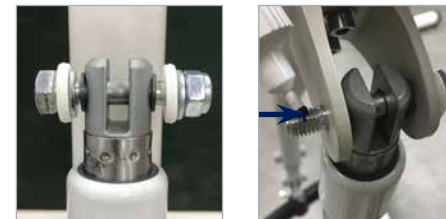

### 3. Apply thread locker / loctite

- Locate actuator mounting hardware.
- Install actuator hardware. A few drops of medium strength thread locker / loctite must be applied to the bolt threads.



### 4. Mount handle

Mount push handle onto mast in position shown and fasten screws with Allen key.

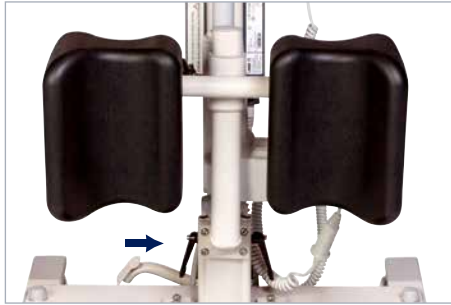

### 5. Attach the knee pads

Position the knee pads onto the mount point located toward the base of the lifter. Attach with four fixing bolts (supplied)



### 6. Connecting the actuator

- Connect grey actuator lead into port (1) located on base of the control unit.
- Connect the other end into the female lead from the actuator.



### 7. Connecting the handset

Connect grey handset lead into port located on base of control unit.



### 8. Connecting the Leg Spread Actuator

Connect black actuator lead port (2) on base of control unit.

## 8. PRELIMINARY CHECKS

After charging the battery these checks should be completed prior to initially using the standing lifter:

- Check handset functionality is correct.
- Check to see that all indicator lights are functioning.
- Check that the emergency stop button causes the standing lifter to stop.
- Check emergency lowering function.
- Check that all leads are inserted, fastened and clear of the rear castors.

## 9. STANDING LIFTER OPERATION

### Handset

Features:

- Raise / Lower function buttons
- Leg spread function buttons
- Battery charge indicators
- Service indicator
  - Press and hold the raise / lower or leg spread function buttons to activate. Release to deactivate. Beware of obstacles at all times to ensure boom and legs can move freely.
  - Battery charge indicators will flash when battery reaches maximum recommended discharge of 18 volts, while the lifter is under load.
  - Service indicator will illuminate when lifter has reached recommended service interval, either 12 months since last service or 8000 lift cycles. At this time the lifter needs to be serviced for safety and to maintain applicable warranty. A full load test should be completed at least every 12 months by an Aidacare service technician.







### Emergency Lowering

To activate emergency lowering lift up red tab located on top of actuator housing.

This allows the patient to be fully lowered in the event of a fault in the lifter or discharged batteries.

### Kneepad Adjustment

Adjust kneepad height by loosening hand wheel bolt on upright post. Set to desired height and fasten back in place.

Adjust knee pad width by releasing spring pins on each side, allowing the pin to auto-locate into the preset positions. Set to desired width and fasten back in place.

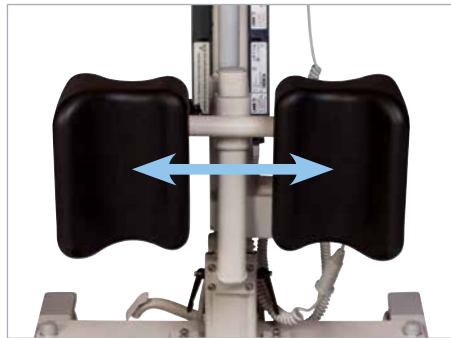

### Yoke Depth Adjustment

Release adjustment pin and adjust yoke to required depth. Re-secure pin in place.

To remove yoke completely (for example if inspection is required) the grub screw under the boom needs to be removed. Always ensure it is replaced afterwards.



### Charging the battery

The A2005 Standing Lifter is supplied with a LINAK external wall mount charger and is compatible with standard Australian power outlets.

The following steps should be completed to recharge the battery pack correctly:

- Remove the battery pack from the lifter via the top mounted release lever.
- Connect the battery pack to the charger.



Charger will automatically activate the charging sequence and a light will illuminate to show charging has commenced.

### CHARGING INDICATOR DISPLAY

**GREEN LIGHT** indicates mains power is connected to 240V power supply.

**ORANGE LIGHT** indicates battery is charging, and will turn off automatically when battery is fully charged.



## Charging Dos & Don'ts:



### ALWAYS

- Charge the battery whenever possible, to maximise battery life. Allowing batteries to fully discharge can reduce the useful life of a battery.
- Always inspect all cables particularly the mains power cable on the charger for any damage; replace if any signs of damage or wear are visible.
- Always stow the handset, charger and mains power cable when transporting the lifter to prevent loss and or damage.
- Always clean the actuators, control box, charger, battery and handset at regular intervals to remove dust/dirt.



### NEVER

- Never allow the battery to fully discharge before recharging. Allowing batteries to fully discharge can reduce the useful life of a battery.

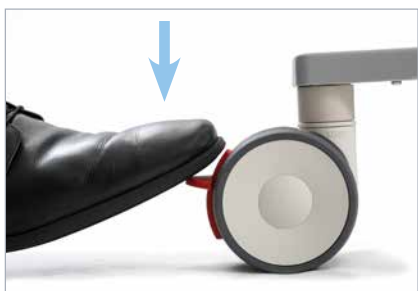

### Castors

To **engage the castor brake** place your foot on the brake pedal and apply sufficient downward force to move it into the lock position.



To **disengage the castor brake** simply place the point of your toe underneath the brake pedal and lift-up.

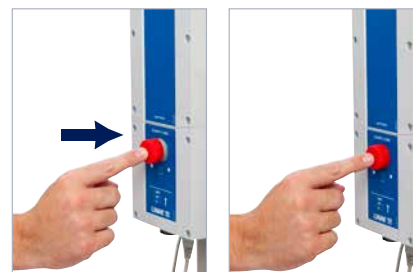

### Emergency Stop

To **engage the emergency stop** press the red button located on the control unit until it sits flush and remains in position.



To **disengage the emergency stop** function twist the red button clockwise until it pops out.

## 10. STANDING GUIDE

It is important that carers are familiar with manual handling techniques along with any sling instructions prior to completing any patient lifts. All patient's should have the correct sling and transfer techniques assessed by a qualified health professional. Explaining the lift process to the patient is important to ensure patient comfort and confidence and whenever possible two carers should conduct patient lifts for additional safety.



### 1. User sling positioning

Ensure that the user is ready and lean them forward. Slide the sling down behind the user until the underarm pads are just below the axilla (arm pit). Pull the straps and loops through under the user's arms and fasten the chest strap in place.





## 2. Attaching the sling to the yoke

Ensure that the standing lifter legs are open to the maximum width and slowly position it as close to the front of the chair as possible – be careful to keep the boom and yoke clear of the user during this process.

The user's feet should be positioned on the foot platform shoulder width apart. The user should grip the yoke handles for stability.

Once the yoke is at chest height on the user the sling loops can be attached. For chair lifts the rear brake castors should not be used to ensure the standing lifter can locate its centre of gravity easily.



## 3. Lifting the user

As the straps pull tight but before the user's bottom leaves the support surface underneath, ensure the sling is positioned appropriately and that the sling loops are attached securely.

## 11. SLING COMPATIBILITY

The Deluxe Padded Standing Sling has been developed to work seamlessly with the Aidacare Aspire range of standing lifters.

This standing lifter may also be suitable for use with other brands of slings. To confirm if a sling is compatible with any of the Aidacare Aspire range of patient lifting systems contact Aidacare.

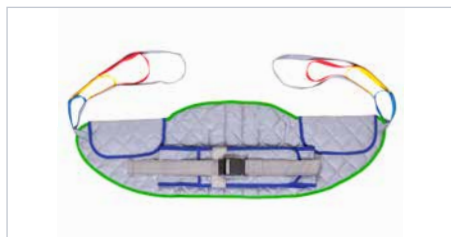

Deluxe Padded Standing Sling

## 12. CARE & MAINTENANCE

To prolong the working life of the standing lifter and for trouble free operation it is recommended that periodic inspections should be performed routinely by a person who is suitably qualified and well acquainted with the design, use and care of patient standing lifters.

If inspection reveals that the safety of the standing lifter is jeopardized in any way the standing lifter should be **IMMEDIATELY WITHDRAWN FROM SERVICE**, tagged as such and the owner notified.

### Common Checks, Maintenance and Cleaning

- Check castors are fastened securely to the frame
- Castors should run and swivel smoothly – if hair or other fibres have built up within the castor this should be removed
- Check that the brakes on the rear castors function normally
- Clean surfaces with a pH neutral detergent – chlorine and phenol based detergents should not be used as these may damage standing lifter components
- All moving parts and pivot points should be checked for fatigue and lubricated if necessary
- All electrical components should be checked for normal function including battery and battery charger
- The actuator shaft should only be wiped with a cloth. **DO NOT** lubricate. Should you have any questions, contact Aidacare.

AS A MINIMUM A FULL SERVICE SHOULD BE COMPLETED EVERY 6 MONTHS AND THE LOAD TEST EVERY 12 MONTHS TO MAINTAIN WARRANTY.

ELECTRICAL TEST & TAG – WHERE LIFTERS ARE IN USE IN A COMMERCIAL ENVIRONMENT THEN THE TESTING REGIME APPLIED SHOULD ALIGN WITH THE RISK ASSESSMENT MADE BY THE OWNER FOR SAFETY AND OTHER COMPLIANCE REQUIREMENTS.

TO MAINTAIN GLOBAL STANDARDS COMPLIANCE UNDER AS ISO 10535-2011 A FULL SWL TEST MUST BE COMPLETED EVERY 12 MONTHS.

## 13. COMPLIANCE

---

This lifter is manufactured in ISO compliant production facilities in PR China to strict quality control standards.

Aidacare Aspire lifters are manufactured and independently tested to the market relevant compliance standards.

Labels on the lifter address compliance requirements and users should familiarise themselves with these prior to use.

## 14. WARRANTY & SERVICE

---

### LIFTER AND ELECTRONICS

AIDACARE warrants its products to be free from defects in materials and workmanship under normal use and service and will within the period stated below, from the date of purchase, repair or replace without cost to the original customer, any part assembly or portion thereof which shall be returned to AIDACARE and from OUR inspection shows to be defective.

1. Standing Lifter Frame – 5 years
2. LINAK Actuator and LINAK Controller – 3 years (excluding Battery Pack)
3. LINAK Battery Pack & Handset – 12 month manufacturer's warranty subject to stringent fair wear and tear clauses (please contact AIDACARE for a copy of this information)

### **WARRANTY IS CONTINGENT UPON ANNUAL SERVICING BEING COMPLETED FOR THE LENGTH OF THE WARRANTY PERIOD.**

AIDACARE cannot be held responsible for any personal injury, damage to the standing lifter or damage to property as a result of the improper or unsafe use of the product.

No warranty claim shall apply where the product or any part thereof has been modified, varied, altered or damaged either accidentally or through improper or negligent use.

No warranty claim shall apply where the standing lifter is repaired or serviced by parties other than those accredited and or approved by Aidacare.

Warranty does not extend to items or components which may require replacement due to normal wear and tear (e.g. castors, plastic molded components, foam padding (where fitted) and painted surfaces) for which AIDACARE nor its distributors can be held responsible.

### **BATTERIES**

Batteries carry a limited warranty from the original manufacturer which is subject to a stringent wear and tear clause. Battery faults due to defect in original manufacture typically become apparent within the first two months of use.

Any gradual deterioration in performance after this period is typically associated with fair wear and tear, misuse and accidental damage, and as such is not covered by the LINAK manufacturer's warranty.

**ALL WARRANTIES MADE ARE BACK TO BASE WARRANTIES MEANING THAT ANY PARTS OR WHOLE STANDERS REQUIRING REPAIR NEED TO BE RETURNED TO THE NEAREST AIDACARE SERVICE CENTRE AT THE CUSTOMER'S EXPENSE – PLEASE CONTACT AIDACARE FOR A CURRENT LIST OF SERVICE CENTRE LOCATIONS.**

### **SPARE PARTS**

SPARE PARTS LIST AVAILABLE UPON REQUEST FROM AIDACARE

### **CUSTOMISATION AND MODIFICATION**

All lifter customisation, modifications and or alterations made to this product are considered as "custom" changes. These may cause the product to no longer meet safety standards and should be considered prior to commencement.

Any customisation or modification of the lifter is not warranted by Aidacare and will void the warranty.

## 15. TROUBLESHOOTING

---

**WARNING: TROUBLESHOOTING SHOULD ONLY BE CARRIED OUT BY AIDACARE AUTHORISED SERVICE TECHNICIANS WHO ARE TRAINED IN SERVICING THE ELECTRICAL AND MECHANICAL FEATURES OF THE STANDING LIFTER.**

The following is a guideline only to general troubleshooting.

Before carrying out any troubleshooting:

- CHECK TO ENSURE the RED emergency stop button is NOT pushed in.
- CHECK TO ENSURE maintenance procedures have been followed.
- CHECK TO ENSURE all lead connections are secure.
- CHECK TO ENSURE the battery is fully charged.

## 16. PRODUCT SPECIFICATIONS

PROBLEM	POTENTIAL FAULT	ACTION
<ul style="list-style-type: none"> <li>Warning alarm can be heard in control unit</li> </ul>	<ul style="list-style-type: none"> <li>Battery is discharged</li> <li>Battery may be faulty</li> </ul>	<ul style="list-style-type: none"> <li>Recharge battery</li> <li>Replace battery</li> </ul>
<ul style="list-style-type: none"> <li>Power LED on charger does not illuminate</li> </ul>	<ul style="list-style-type: none"> <li>Not connected to power</li> <li>Fuse blown</li> <li>Faulty Charger</li> </ul>	<ul style="list-style-type: none"> <li>Check plugged in to power point and switched on</li> <li>Replace fuse</li> <li>Repair or replace charger</li> </ul>
<ul style="list-style-type: none"> <li>Actuator not running/ no click heard from control unit when buttons pressed</li> </ul>	<ul style="list-style-type: none"> <li>Faulty control unit</li> <li>Faulty handset</li> </ul>	<ul style="list-style-type: none"> <li>Repair or replace control unit</li> </ul>
<ul style="list-style-type: none"> <li>Actuator not running but control unit clocks when buttons pressed</li> </ul>	<ul style="list-style-type: none"> <li>Actuator plug not inserted fully into control unit</li> <li>Faulty actuator</li> <li>Faulty control unit</li> </ul>	<ul style="list-style-type: none"> <li>Check plugs are completely inserted into control unit ports</li> <li>Repair or replace actuator and or control unit</li> </ul>
<ul style="list-style-type: none"> <li>Actuator not lifting properly or running slowly</li> </ul>	<ul style="list-style-type: none"> <li>Discharged or faulty battery</li> <li>Weight in excess of safe working load (SWL)</li> <li>Faulty actuator</li> </ul>	<ul style="list-style-type: none"> <li>Recharge or replace battery</li> <li>Repair or replace actuator</li> </ul>
<ul style="list-style-type: none"> <li>No clicking in control box when buttons pressed</li> </ul>	<ul style="list-style-type: none"> <li>Emergency stop button pressed</li> <li>Battery completely discharged</li> <li>Battery fuse faulty</li> <li>Faulty control unit</li> </ul>	<ul style="list-style-type: none"> <li>Release emergency stop button</li> <li>Recharge battery</li> <li>Repair or replace control unit</li> </ul>
<ul style="list-style-type: none"> <li>Actuator only works in one direction</li> </ul>	<ul style="list-style-type: none"> <li>Faulty handset</li> <li>Faulty control unit</li> <li>Emergency lower release activated</li> </ul>	<ul style="list-style-type: none"> <li>Repair or replace handset</li> <li>Repair or replace control unit</li> <li>Check emergency actuator release is reset</li> </ul>

Product Code	LSS390640	LSS390640-UK
Safe Working Load (SWL)	200kg	31.5st
Base Length	1072mm	42"
External Base Width	590 – 1040mm	23" – 41"
Internal Base Width	490 – 940mm	19.5" – 37"
Base Width Adjustment	Electric	
Base Height / Under Bed Clearance	110mm	4"
Minimum Height of Spreader Bar	880mm	35"
Maximum Height of Spreader Bar	1415mm	56"
Standing Lifter Weight	33kg	73lb
Warranty	Frame: 5 Years Electronics: 3 Years Battery Pack: 1 Year	
Under Base Height	50mm	2"
Maximum Overall Height	1480mm	58"
Front Castor Diameter	75mm	3"
Rear Locking Castor Diameter	75mm	3"
Turning Diameter	1160mm	46"
Weight Of Heaviest Part (Base Assembly)	19.6kg	43lb
Handle Height	1025mm	40.5"
Sound Level	<40Db@ 1m	
Electrical Approval	EN 60601-1-2:2007; EN 61000-3-2:2006; EN 6100-3-3:2008	

Box Contains: Base with 4 castor wheels, mast and boom with yoke, LINAK handset, LINAK battery charger, LINAK battery, LINAK controller, push handle. Screws, bolts, nuts, washers, plastic caps and tool kit.

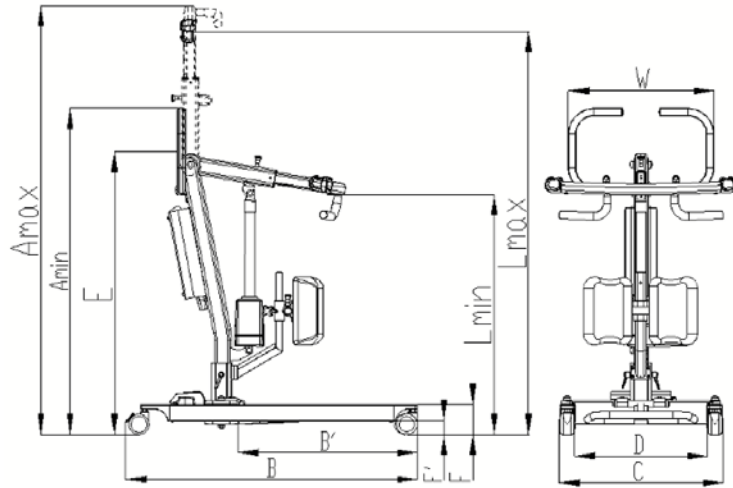

## 17. MANUFACTURER, UK REPRESENTATIVE & IMPORTER DETAILS



Max. Load and Net Weight in kg, the rest of the measurements are in cm (unmarked tolerance +/- 1cm)														
Item No.	Max. Load	A		B	B'	C	D	E	F	F'	L		W	Turning Diameter
		Max.	Min.								Max.	Min.		
7201	200	Max.	Min.	107.2	65.6	59-104 (tolerance +/- 2cm)	49-94 (tolerance +/- 2cm)	102.5	11	5	Max.	Min.	53	116
		148	118								141.5	88		

## 15. RECYCLING INSTRUCTION

This product is fitted with electronic components and should not be mixed with general household waste. Please follow the diagram below to identify materials on the product. Old batteries and electronics are to be taken to your nearest recycling centre for recycling or contact your retailer.

-  Lead Battery (Pb)
-  Waste of Electrical and Electronic Equipment (WEEE)
-  Metals

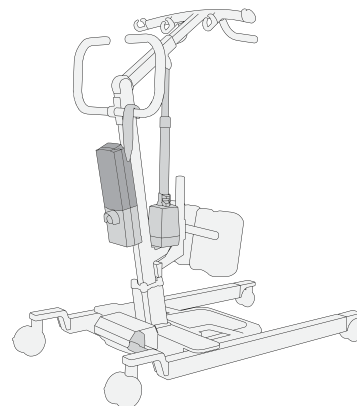

If you have any questions, you can contact:



### Manufacturer:

**Aidacare Pty Ltd**

ABN 40 134 398 833

Building 3A, 1 Moorebank Avenue,  
Moorebank NSW 2170  
Australia

1300 133 120 | [product@aidacare.com.au](mailto:product@aidacare.com.au)



### UK Representative:

**European Device Solutions Ltd**

15 Coanwood Drive,  
Whitley Bay Tyne and Wear NE25 9GB  
United Kingdom

[info@europeandevicesolutions.co.uk](mailto:info@europeandevicesolutions.co.uk)



### Importer:

**Aidacare Ltd**

Registration 13785408

Arcadia House, Maritime Walk, Ocean Village,  
Southampton SO14 3TL  
United Kingdom

01622 541235 | [info@aidacare.co.uk](mailto:info@aidacare.co.uk)

## **AIDACARE PTY LTD**

Building 3A, 1 Moorebank Avenue,  
Moorebank NSW 2170  
Australia

**1300 133 120** | [aidacare.com.au](http://aidacare.com.au)

## **AIDACARE LIMITED**

Arcadia House, Maritime Walk,  
Ocean Village, Southampton SO14 3TL  
United Kingdom

**01622 541235** | [aidacare.co.uk](http://aidacare.co.uk)

MADE IN PRC

ABUM06.34 211223

